

Best Quality and
Delivery since 1968

RESPONSIVE
DELIVERY

EXTRAORDINARY
RELIABILITY

HAND-CRAFTED
QUALITY

M S I

MINI-SYSTEMS, INC

Thick Film Division

MINI-SYSTEMS

Precision Components & Services

History of Mini-Systems, Inc. (MSI)

Mini-Systems, Inc. is a leading manufacturer of precision thick and thin film chip resistors, capacitors, metal/glass sidewall packages, custom thick film hybrid circuits, and multi-chip modules. Since 1968, our commitment to total quality and responsive customer service has helped us maintain this leadership status.

MSI is consistently called upon when high reliability and high performance are required in a broad range of applications including satellite, medical, spacecraft, and military. Our parts have been supplied for programs such as:

- ❖ F-18
- ❖ MX
- ❖ Trident
- ❖ Patriot
- ❖ Space Shuttle
- ❖ Voyager
- ❖ Mariner
- ❖ Heart Pacers

Since our inception, we have known that understanding customer service and fast response is the key to building long-lasting customer relationships. We look forward to giving you a personal introduction to our company in the near future.

Quality

- ❖ Uncompromising Product Specifications
- ❖ Process Integrated Quality Assurance
- ❖ Advanced Testing Equipment and Facilities

Reliability

- ❖ Established Reliability of QPL Products to MIL-PRF-55342
- ❖ Innovative Design Criteria for Maximum Product Performance
- ❖ SPC Process Control and Monitoring

Delivery

- ❖ Consistently the Shortest Available Lead Times
- ❖ Expedited Delivery Available for Your Critical Needs
- ❖ Many Standard Products Maintained in Stock

Service

- ❖ Knowledgeable Sales and Engineering Support
- ❖ Rapid Response to All Your Questions and Inquiries
- ❖ Committed to Total Customer Satisfaction

Expertise

- ❖ Highly Trained, Dedicated Staff
- ❖ Extensive Microelectronics Background in Materials, Assembly, Design, and Testing
- ❖ Customized Solutions to Your Hybrid Microelectronics Requirements

Thick Film

ISO 9001
Certified

- ❖ The WORLD'S FIRST Supplier of QPL/ I & 13, 0502 & 0302 Style Resistors
- ❖ High Reliability, Precision, Thick Film Chip Resistors and Networks
- ❖ QPL Approved to MIL-PRF-55342, "T" Space Level Qualified
- ❖ Surface Mount, Wire Bondable, and Flip Chip Configurations
- ❖ T and Pi, Low Loss, Chip Attenuators
- ❖ Standard and Custom, Gold on Ceramic, Jumpers and Standoffs

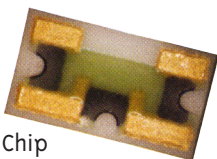

Chip Attenuator

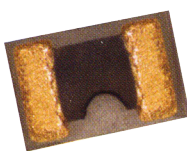

Wire Bondable Resistor

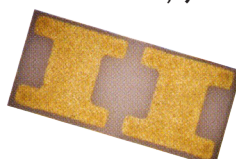

Mounting Pad



Resistor Network



Wraparound Resistor

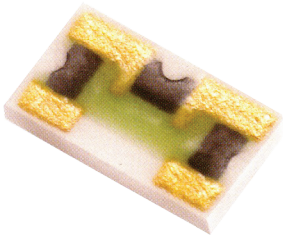
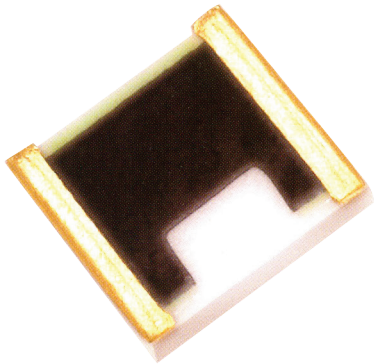
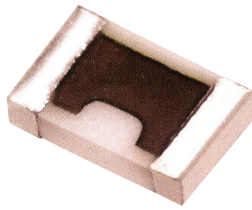

What's ahead...

Ordering MSI Thick Film Parts

Part Numbering System, Case Sizes, Power Ratings, Voltage Ratings, TCR's & Electrical Performance Characteristics **4-5**

Mini WA / WA Series Resistors

MWA & WA Mechanical Data —Style/Type, Case Size, Length, Width, Thickness & Pad Width **6-7**

Mini HW / HW Series Resistors

MHW & HW Mechanical Data —Style/Type, Case Size, Length, Width, Thickness & Pad Width **8-9**

Mini MSR / MSR Series Resistors

MSR Mechanical Data —Style /Type, Case Size, Length, Width, Thickness & Pad Width **10-11**

QPL Precision Resistors

Top Contact (MSR) & Wrap Around (WA) Descriptions, Part Numbering System, Electrical & Mechanical Data **12-17**

Thick Film Chip Attenuators

Description, Mechanical & Electrical Data & Part Numbering System **18-19**

Thick Film Jumpers

Description, Mechanical & Electrical Data & Part Numbering System **20**

Mounting Pads And Kits

Thick Film Gold Mounting Pads, Part Numbering System, Jumper & Mounting Pad Kits **21**

Surface Mount Resistor Networks

Description, Mechanical & Electrical Data, Electrical Performance Characteristics & Part Numbering System **22-23**

MSIRP Reliability Program

Samples Being Selected, Applicable Military Standards, Tests Being Performed & Data From Test Results **24-25**

Thick Film Process Capabilities

Products, Applications, Metallizations, Substrates, Testing & Equipment **26-27**

Construction of MSI Precision Chip Resistors

Illustration Of The Unique 5 Sided Wrap Around Resistor, Design & Fabrications Used To Maximize Performance **28**

Ordering MSI Thick Film Parts

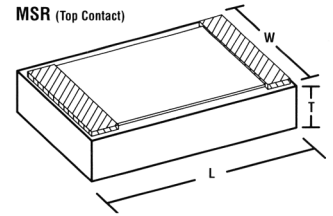
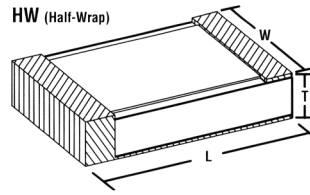
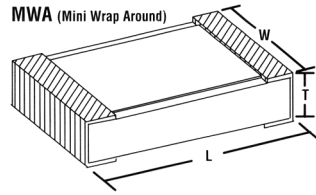
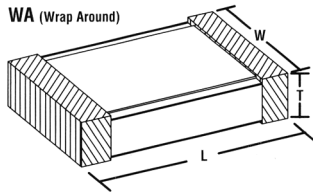

PART NUMBER DESIGNATION

EXAMPLE: WA81PG -1001F-NS62TR

Wrap Around, 0502 case size, Platinum Gold base metal, 1kΩ 1% tol., Nickel Barrier, Sn62 Solder, Tape & Reel, Std TCR

Style: WA WA = Wrap Around
MWA = Mini Wrap Around
HW = Half Wrap
MHW = Mini Half Wrap
MSR = Top Contact

Type: 81 See Table to right

Termination: PG G = Gold for wire bonding (MSR only)
PG = Platinum Gold
PS = Palladium Silver
SM = Surface Mount
Base Metal
Base metal determined by value
And TCR (Nickel Barrier required)

Value: 1001 Four digits (xxxx) with provisions for five digits (xxxxx) if necessary. The first three digits represent significant figures. The last digit represents the number of zeros to follow. When fractional values of an ohm are required, the letter "R" is used as a decimal point.
Resistance Value

Tolerance: F B = 0.10% H = 3% P = 25%
C = 0.25% J = 5% N = 30%
E = 0.50% K = 10% Y = Max
F = 1% L = 15% Z = Special
G = 2% M = 20%

Metal Options: N B = Back Metal (MSR only)
N = Nickel Barrier
Blank = No Metal Options

Termination: S62 S60 = Sn60 Lead Free Options
S62 = Sn62 S96 = Sn96
S63 = Sn63 CA = CASTIN
U = Untinned No Solder
NU = Nickel, Gold Plate
Finish

Options: TR TR = Tape and Reel (Heat seal std)
Pressure seal & Paper tape available
Packaged in chip trays if not specified
TL = Trimless
P = Optimum TCR otherwise std.
X = Special Requirements Code

Style	Type	Case Size	Power (Watts)	Voltage (Volts DC)
MWA	96	0201	0.015	20
	84	0202	0.020	25
	66	0203	0.040	30
MHW	98	0302	0.040	30
MSR	91	0303	0.040	40
	10	0404	0.050	45

Style	Type	Case Size	Power (Watts)	Voltage (Volts DC)
WA	20	0402	0.040	40
	81	0502	0.100	50
	56	0503	0.125	80
HW	19	0504	0.100	70
	82	0505	0.125	80
MSR	93	0603	0.090	90
	61	0604	0.125	65
	86	0805	0.200	125
	5	1002	0.100	175
	83	1005	0.250	180
	90	1010	0.500	160
	87	1206	0.250	190
	94	1210	0.550	230
	97	1218	1.500	185
	80	1505	0.300	300
	88	2010	0.800	350
	85	2307	0.500	380
	89	2512	2.000	475
68	3939	5.000	750	
30	5024	4.000	1000	
28	6632	8.000	1400	
26	6645	8.000	1400	

RESISTANCE RANGE IN OHMS

Type	0.1 to < 1	1 to < 5	5 to < 10	10 to < 1M	1M to < 10M	10M to < 100M	100M to < 250M	250M to < 500M	500M to < 750M	750M to < 1G
96	400	300	200	100	200	200	300	300	400	400
84	300	100	100	100	200	200	300	300	400	400
66	300	100	100	100	200	200	300	300	400	400
98	300	100	100	100	100	200	300	300	400	400
91	100	100	100	100	100	100	150	200	300	300
10	100	100	100	100	100	200	200	200	300	300
20	300	100	100	100	100	100	300	300	400	400
81	100	100	100	100	100	100	200	200	300	300
56	100	100	100	100	100	100	200	200	300	300
19	100	100	100	100	100	100	150	200	300	300
82	100	100	100	100	100	100	150	200	300	300
93	100	100	100	100	100	100	150	200	300	300
61	100	100	100	100	100	100	150	200	300	300
86	100	100	100	100	100	100	300	200	300	300
5	500	200	200	100	100	200	200	200	200	200
83	100	100	100	100	100	100	150	200	300	300
90	100	100	100	100	100	100	200	300	400	400
87	100	100	100	100	100	100	150	200	300	300
94	100	100	100	100	100	100	200	300	400	400
97	200	100	100	100	100	200	200	300	400	400
80	500	300	100	100	100	100	100	100	200	200
88	100	100	100	100	100	100	150	200	300	300
85	500	300	100	100	100	100	100	100	200	200
89	100	100	100	100	100	100	150	200	300	300
68	100	100	100	100	100	100	200	300	400	400
30	200	100	100	100	100	100	150	200	300	300
28	200	100	100	100	100	100	150	200	300	300
26	200	100	100	100	100	100	150	200	300	300

1. Table list optimal TCR's, add 200 standard TCR's 2. Optimal TCR's valid for SM termination, may not be available for all other terminations.

Electrical Performance Characteristics

MIL-PRF-55342	MIL-PRF-55342 Requirement	MSI Typical
Short Term Overload	±0.25%	±0.03%
High Temperature Exposure	±0.50%	±0.05%
Thermal Shock	±0.50%	±0.07%
Low Temperature Operation	±0.25%	±0.05%
Resistance to Bonding Exposure / Soldering Heat	±0.25%	±0.09%
Moisture Resistance	±0.50%	±0.06%
Stability (Life 70°C 2,000Hrs)	±0.50%	±0.04%
Stability (Life 70°C 10,000Hrs)	±2.00%	±0.07%

Operating temperature range from 55°C to +150°C

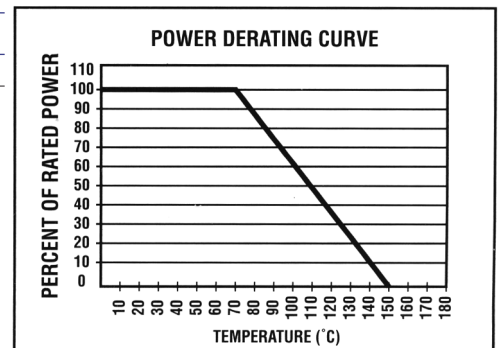

Power rating at 70° C derated linearly to 0% power at 150°C (P=E²/R).

Mini WA Series Resistors



Style	Type	Case Size	Length Inches (mm)	Width Inches (mm)	Thickness Inches (mm)	Pad Width Inches (mm)
MHW	96	0201	0.024 ±0.002 (0.610 ±0.051)	0.012 ±0.002 (0.305 ±0.051)	0.008 ±0.002 (0.203 ±0.051)	0.007 ±0.002 (0.178 ±0.051)
	84	0202	0.024 ±0.002 (0.610 ±0.051)	0.021 ±0.002 (0.533 ±0.051)	0.008 ±0.002 (0.203 ±0.051)	0.007 ±0.002 (0.178 ±0.051)
	66	0203	0.027 ±0.002 (0.686 ±0.051)	0.031 ±0.002 (0.787 ±0.051)	0.012 ±0.003 (0.305 ±0.076)	0.008 ±0.002 (0.203 ±0.051)
	98	0302	0.032 ±0.003 (0.813 ±0.076)	0.020 ±0.003 (0.508 ±0.076)	0.012 ±0.003 (0.305 ±0.076)	0.008 ±0.003 ¹ (0.203 ±0.076)
	91	0303	0.030 ±0.003 (0.762 ±0.076)	0.030 ±0.003 (0.762 ±0.076)	0.012 ±0.003 (0.305 ±0.076)	0.008 ±0.003 ¹ (0.203 ±0.076)
	10	0404	0.037 ±0.003 (0.940 ±0.076)	0.035 ±0.003 (0.889 ±0.076)	0.012 ±0.003 (0.305 ±0.076)	0.012 ±0.004 (0.305 ±0.102)

¹ Dimension are for back terminals

WA Series Resistors

Style	Type	Case Size	Length Inches (mm)	Width Inches (mm)	Thickness Inches (mm)	Pad Width Inches (mm)
HW	20	0402	0.044 ±0.004 (1.118 ±0.102)	0.022 ±0.003 (0.559 ±0.076)	0.013 ±0.003 (0.330 ±0.076)	0.011 ±0.004 (0.279 ±0.102)
	81	0502	0.054 ±0.005 (1.372 ±0.127)	0.025 ±0.003 (0.635 ±0.076)	0.013 ±0.003 (0.330 ±0.076)	0.015 ±0.005 ¹ (0.381 ±0.127)
	56	0503	0.050 ±0.005 (1.270 ±0.127)	0.032 ±0.003 (0.813 ±0.076)	0.013 ±0.003 (0.330 ±0.076)	0.015 ±0.005 (0.381 ±0.127)
	19	0504	0.055 ±0.005 (1.397 ±0.127)	0.042 ±0.003 (1.067 ±0.076)	0.013 ±0.003 (0.330 ±0.076)	0.015 ±0.005 ¹ (0.381 ±0.127)
	82	0505	0.054 ±0.005 (1.372 ±0.127)	0.050 ±0.003 (1.270 ±0.076)	0.013 ±0.003 (0.330 ±0.076)	0.015 ±0.005 ¹ (0.381 ±0.127)
	93	0603	0.065 ±0.005 (1.651 ±0.127)	0.032 ±0.003 (0.813 ±0.076)	0.013 ±0.003 (0.330 ±0.076)	0.015 ±0.005 ¹ (0.381 ±0.127)
	61	0604	0.065 ±0.005 (1.651 ±0.127)	0.042 ±0.003 (1.067 ±0.076)	0.018 ±0.003 (0.457 ±0.102.)	0.017 ±0.005 (0.432 ±0.127)

Dimensions are for back termination only.

Style	Type	Case Size	Length Inches (mm)	Width Inches (mm)	Thickness Inches (mm)	Pad Width Inches (mm)
WA	86	0805	0.080 ±0.006 (2.032 ±0.152)	0.050 ±0.003 (1.270 ±0.076)	0.018 ±0.003 (0.457 ±0.076)	0.015 ±0.005 (0.381 ±0.127)
	5	1002	0.105 ±0.005 (2.667 ±0.127)	0.027 ±0.003 (0.686 ±0.076)	0.013 ±0.003 (0.330 ±0.076)	0.020 ±0.005 (0.508 ±0.127)
	83	1005	0.104 ±0.006 (2.642 ±0.152)	0.050 ±0.003 (1.270 ±0.076)	0.018 ±0.004 (0.457 ±0.102)	0.015 ±0.005 (0.381 ±0.127)
	90	1010	0.104 ±0.006 (2.642 ±0.152)	0.100 ±0.003 (2.540 ±0.076)	0.018 ±0.004 (0.457 ±0.102)	0.015 ±0.005 (0.381 ±0.127)
	87	1206	0.127 ±0.006 (3.226 ±0.152)	0.063 ±0.003 (1.600 ±0.076)	0.018 ±0.004 (0.457 ±0.102)	0.019 ±0.005 ¹ (0.483 ±0.127)
	94	1210	0.125 ±0.005 (3.175 ±0.127)	0.100 ±0.003 (2.540 ±0.076)	0.018 ±0.004 (0.457 ±0.102)	0.019 ±0.005 (0.483 ±0.127)
	97	1218	0.120 ±0.005 (3.048 ±0.127)	0.180 ±0.003 (4.572 ±0.076)	0.030 ±0.005 (0.762 ±0.127)	0.025 ±0.005 (0.635 ±0.127)
	80	1505	0.155 ±0.005 (3.937 ±0.127)	0.050 ±0.003 (1.270 ±0.076)	0.018 ±0.004 (0.457 ±0.102)	0.015 ±0.005 (0.381 ±0.127)
	88	2010	0.210 ±0.006 (5.334 ±0.152)	0.098 ±0.003 (2.489 ±0.076)	0.018 ±0.004 (0.457 ±0.102)	0.020 ±0.005 (0.508 ±0.127)
	85	2307	0.228 ±0.005 (5.791 ±0.127)	0.075 ±0.003 (1.905 ±0.076)	0.018 ±0.004 (0.457 ±0.102)	0.020 ±0.005 (0.508 ±0.127)
	89	2512	0.256 ±0.006 (6.502 ±0.152)	0.124 ±0.003 (3.150 ±0.076)	0.030 ±0.005 (0.762 ±0.127)	0.020 ±0.005 (0.508 ±0.127)
	68	3939	0.394 ±0.008 (10.008 ±0.203)	0.390 ±0.005 (9.906 ±0.127)	0.030 ±0.005 (0.762 ±0.127)	0.043 ±0.005 (1.092 ±0.127)
	30	5024	0.501 ±0.008 (12.725 ±0.203)	0.246 ±0.004 (6.248 ±0.102)	0.030 ±0.005 (0.762 ±0.127)	0.058 ±0.005 (1.473 ±0.127)
	28	6632	0.674 ±0.008 (17.120 ±0.203)	0.332 ±0.005 (8.443 ±0.102)	0.030 ±0.005 (0.762 ±0.127)	0.067 ±0.006 ¹ (1.702 ±0.152)
26	6645	0.675 ±0.009 (17.145 ±0.229)	0.499 ±0.005 (12.675 ±0.127)	0.030 ±0.005 (0.762 ±0.127)	0.067 ±0.006 ¹ (1.702 ±0.152)	

Dimensions are for back termination only.

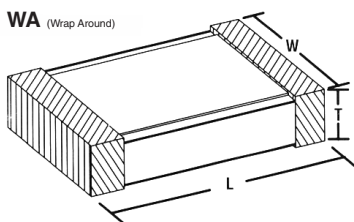

Mini HW Series Resistors



Style	Type	Case Size	Length Inches (mm)	Width Inches (mm)	Thickness ¹ Inches (mm)	Top Contact Pad Width Inches (mm)
MHW	96	0201	0.023 ±0.002 (0.584 ±0.051)	0.012 ±0.002 (0.305 ±0.051)	0.008 ±0.002 (0.203 ±0.051)	0.005 ±0.002 (0.127 ±0.051)
	84	0202	0.023 ±0.002 (0.584 ±0.051)	0.021 ±0.002 (0.533 ±0.051)	0.008 ±0.002 (0.203 ±0.051)	0.005 ±0.002 (0.127 ±0.051)
	66	0203	0.026 ±0.002 (0.660 ±0.051)	0.031 ±0.002 (0.787 ±0.051)	0.013 ±0.003 (0.330 ±0.076)	0.006 ±0.002 (0.152 ±0.051)
	98	0302	0.031 ±0.003 (0.787 ±0.076)	0.020 ±0.003 (0.508 ±0.076)	0.013 ±0.003 (0.330 ±0.076)	0.006 ±0.002 (0.152 ±0.051)
	91	0303	0.029 ±0.003 (0.736 ±0.076)	0.030 ±0.003 (0.762 ±0.076)	0.0130 ±0.003 (0.330 ±0.076)	0.006 ±0.002 (0.152 ±0.051)
	10	0404	0.036 ±0.003 (0.914 ±0.076)	0.035 ±0.003 (0.889 ±0.076)	0.013 ±0.003 (0.330 ±0.076)	0.009 ±0.002 (0.229 ±0.051)

¹ Solder may add up to an additional 0.004* in thickness.

HW Series Resistors

Style	Type	Case Size	Length Inches (mm)	Width Inches (mm)	Thickness ¹ Inches (mm)	Top Contact Pad Width Inches (mm)
HW	20	0402	0.043 ±0.004 (1.092 ±0.102)	0.022 ±0.003 (0.559 ±0.076)	0.013 ±0.003 (0.330 ±0.076)	0.009 ±0.002 (0.229 ±0.051)
	81	0502	0.051 ±0.004 (1.295 ±0.102)	0.025 ±0.003 (0.635 ±0.076)	0.013 ±0.003 (0.330 ±0.076)	0.010 ±0.002 (0.254 ±0.051)
	56	0503	0.048 ±0.004 (1.219 ±0.102)	0.032 ±0.003 (0.813 ±0.076)	0.013 ±0.003 (0.330 ±0.076)	0.011 ±0.002 (0.279 ±0.051)
	19	0504	0.053 ±0.004 (1.346 ±0.102)	0.042 ±0.003 (1.067 ±0.076)	0.013 ±0.003 (0.330 ±0.076)	0.011 ±0.002 (0.279 ±0.051)
	82	0505	0.051 ±0.004 (1.295 ±0.102)	0.050 ±0.003 (1.270 ±0.076)	0.013 ±0.003 (0.330 ±0.076)	0.009 ±0.002 (0.229 ±0.051)
	93	0603	0.063 ±0.004 (1.600 ±0.102)	0.032 ±0.003 (0.813 ±0.076)	0.013 ±0.003 (0.330 ±0.076)	0.010 ±0.002 (0.254 ±0.051)
	61	0604	0.063 ±0.004 (1.600 ±0.102)	0.042 ±0.003 (1.067 ±0.076)	0.018 ±0.004 (0.457 ±0.102)	0.013 ±0.002 (0.330 ±0.051)

¹ Solder may add up to an additional 0.004* in thickness.

Style	Type	Case Size	Length Inches (mm)	Width Inches (mm)	Thickness Inches (mm)	Top Contact Pad Width Inches (mm)
HW	86	0805	0.078 ±0.004 (1.981 ±0.102)	0.050 ±0.003 (1.270 ±0.076)	0.018 ±0.004 (0.457 ±0.102)	0.013 ±0.002 (0.330 ±0.051)
	5	1002	0.103 ±0.004 (2.616 ±0.102)	0.027 ±0.003 (0.686 ±0.076)	0.013 ±0.003 (0.330 ±0.076)	0.016 ±0.002 (0.406 ±0.051)
	83	1005	0.101 ±0.004 (2.565 ±0.102)	0.050 ±0.003 (1.270 ±0.076)	0.018 ±0.004 (0.457 ±0.102)	0.013 ±0.002 (0.330 ±0.051)
	90	1010	0.101 ±0.004 (2.565 ±0.102)	0.100 ±0.003 (2.540 ±0.076)	0.018 ±0.004 (0.457 ±0.102)	0.012 ±0.002 (0.305 ±0.051)
	87	1206	0.123 ±0.004 (3.124 ±0.102)	0.063 ±0.003 (1.600 ±0.076)	0.018 ±0.004 (0.457 ±0.102)	0.015 ±0.002 (0.381 ±0.051)
	94	1210	0.123 ±0.004 (3.124 ±0.102)	0.100 ±0.003 (2.540 ±0.076)	0.019 ±0.004 (0.483 ±0.102)	0.015 ±0.002 (0.381 ±0.051)
	97	1218	0.118 ±0.004 (2.997 ±0.102)	0.180 ±0.003 (4.572 ±0.076)	0.030 ±0.005 (0.762 ±0.127)	0.022 ±0.002 (0.559 ±0.051)
	80	1505	0.153 ±0.004 (3.886 ±0.102)	0.050 ±0.003 (1.270 ±0.076)	0.018 ±0.004 (0.457 ±0.102)	0.012 ±0.002 (0.305 ±0.051)
	88	2010	0.207 ±0.004 (5.258 ±0.102)	0.098 ±0.003 (2.489 ±0.076)	0.018 ±0.004 (0.457 ±0.102)	0.017 ±0.002 (0.432 ±0.051)
	85	2307	0.226 ±0.004 (5.740 ±0.102)	0.075 ±0.003 (1.905 ±0.076)	0.018 ±0.004 (0.457 ±0.102)	0.016 ±0.002 (0.406 ±0.051)
	89	2512	0.253 ±0.004 (6.426 ±0.102)	0.124 ±0.003 (3.150 ±0.076)	0.030 ±0.005 (0.762 ±0.127)	0.017 ±0.002 (0.432 ±0.051)
	68	3939	0.390 ±0.006 (9.906 ±0.152)	0.390 ±0.005 (9.906 ±0.127)	0.030 ±0.005 (0.762 ±0.127)	0.040 ±0.002 (1.016 ±0.051)
	30	5024	0.497 ±0.006 (12.624 ±0.152)	0.246 ±0.005 (6.248 ±0.127)	0.030 ±0.005 (0.762 ±0.127)	0.053 ±0.002 (1.346 ±0.051)
	28	6632	0.669 ±0.006 (16.993 ±0.152)	0.332 ±0.005 (8.443 ±0.127)	0.030 ±0.005 (0.762 ±0.127)	0.063 ±0.002 (1.600 ±0.051)
	26	6645	0.669 ±0.006 (16.993 ±0.152)	0.499 ±0.005 (12.675 ±0.127)	0.030 ±0.005 (0.762 ±0.127)	0.063 ±0.002 (1.600 ±0.051)

1 Solder may add up to an additional 0.004* in thickness.

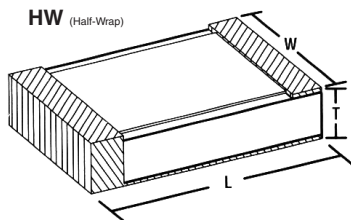

Mini MSR Series Resistors



Style	Type	Case Size	Length Inches (mm)	Width Inches (mm)	Thickness Inches (mm)	Pad Width Inches (mm)
MSR	96	0201	0.022 ±0.002 (0.559 ±0.051)	0.012 ±0.002 (0.305 ±0.051)	0.007 ±0.002 (0.178 ±0.051)	0.005 ±0.002 (0.127 ±0.051)
	84	0202	0.022 ±0.002 (0.559 ±0.051)	0.020 ±0.002 (0.508 ±0.051)	0.007 ±0.002 (0.178 ±0.051)	0.005 ±0.002 (0.127 ±0.051)
	66	0203	0.025 ±0.002 (0.635 ±0.051)	0.030 ±0.002 (0.762 ±0.051)	0.012 ±0.003 (0.305 ±0.076)	0.006 ±0.002 (0.152 ±0.051)
	98	0302	0.030 ±0.002 (0.762 ±0.051)	0.020 ±0.002 (0.508 ±0.051)	0.012 ±0.003 (0.305 ±0.076)	0.006 ±0.002 (0.152 ±0.051)
	91	0303	0.028 ±0.002 (0.711 ±0.051)	0.030 ±0.002 (0.762 ±0.051)	0.012 ±0.003 (0.305 ±0.076)	0.006 ±0.002 (0.152 ±0.051)
	10	0404	0.035 ±0.002 (0.889 ±0.051)	0.035 ±0.002 (0.889 ±0.051)	0.012 ±0.003 (0.305 ±0.076)	0.009 ±0.002 (0.229 ±0.051)

1 Solder may add up to an additional 0.004* in thickness.

MSR Series Resistors

Style	Type	Case Size	Length Inches (mm)	Width Inches (mm)	Thickness ¹ Inches (mm)	Pad Width Inches (mm)
MSR	20	0402	0.040 ±0.002 (1.016 ±0.051)	0.020 ±0.002 (0.508 ±0.051)	0.013 ±0.003 (0.330 ±0.076)	0.009 ±0.002 (0.229 ±0.051)
	81	0502	0.048 ±0.002 (1.219 ±0.051)	0.023 ±0.002 (0.584 ±0.051)	0.013 ±0.003 (0.330 ±0.076)	0.010 ±0.002 (0.254 ±0.051)
	56	0503	0.045 ±0.002 (1.143 ±0.051)	0.030 ±0.002 (0.762 ±0.051)	0.013 ±0.003 (0.330 ±0.076)	0.011 ±0.002 (0.279 ±0.051)
	19	0504	0.050 ±0.002 (1.270 ±0.051)	0.040 ±0.002 (1.016 ±0.051)	0.013 ±0.003 (0.330 ±0.076)	0.011 ±0.002 (0.279 ±0.051)
	82	0505	0.048 ±0.002 (1.219 ±0.051)	0.048 ±0.002 (1.219 ±0.051)	0.013 ±0.003 (0.330 ±0.076)	0.009 ±0.002 (0.229 ±0.051)
	93	0603	0.060 ±0.002 (1.524 ±0.051)	0.030 ±0.002 (0.762 ±0.051)	0.013 ±0.003 (0.330 ±0.076)	0.010 ±0.002 (0.254 ±0.051)
	61	0604	0.060 ±0.002 (1.524 ±0.051)	0.040 ±0.002 (1.016 ±0.051)	0.018 ±0.004 (0.457 ±0.076)	0.013 ±0.002 (0.330 ±0.051)

1 Solder may add up to an additional 0.004* in thickness.

Style	Type	Case Size	Length Inches (mm)	Width Inches (mm)	Thickness ¹ Inches (mm)	Pad Width Inches (mm)
MSR	86	0805	0.075 ±0.002 (1.905 ±0.051)	0.048 ±0.002 (1.219 ±0.051)	0.018 ±0.003 (0.457 ±0.076)	0.013 ±0.002 (0.330 ±0.051)
	5	1002	0.100 ±0.002 (2.540 ±0.051)	0.025 ±0.002 (0.635 ±0.051)	0.013 ±0.003 (0.330 ±0.076)	0.016 ±0.002 (0.406 ±0.051)
	83	1005	0.098 ±0.002 (2.489 ±0.051)	0.048 ±0.002 (1.219 ±0.051)	0.018 ±0.003 (0.457 ±0.076)	0.013 ±0.002 (0.330 ±0.051)
	90	1010	0.098 ±0.002 (2.489 ±0.051)	0.098 ±0.002 (2.489 ±0.051)	0.018 ±0.003 (0.457 ±0.076)	0.012 ±0.002 (0.305 ±0.051)
	87	1206	0.121 ±0.002 (3.073 ±0.051)	0.061 ±0.002 (1.549 ±0.051)	0.018 ±0.003 (0.457 ±0.076)	0.015 ±0.002 (0.381 ±0.051)
	94	1210	0.120 ±0.002 (3.048 ±0.051)	0.098 ±0.002 (2.489 ±0.051)	0.018 ±0.003 (0.457 ±0.076)	0.015 ±0.002 (0.381 ±0.051)
	97	1218	0.115 ±0.002 (2.921 ±0.051)	0.179 ±0.002 (4.547 ±0.051)	0.030 ±0.005 (0.762 ±0.127)	0.022 ±0.002 (0.559 ±0.051)
	80	1505	0.150 ±0.002 (3.810 ±0.051)	0.048 ±0.002 (1.219 ±0.051)	0.018 ±0.003 (0.457 ±0.076)	0.012 ±0.002 (0.305 ±0.051)
	88	2010	0.204 ±0.002 (5.182 ±0.051)	0.096 ±0.002 (2.438 ±0.051)	0.018 ±0.003 (0.457 ±0.076)	0.017 ±0.002 (0.432 ±0.051)
	85	2307	0.223 ±0.002 (5.664 ±0.051)	0.073 ±0.002 (1.854 ±0.051)	0.018 ±0.003 (0.457 ±0.076)	0.016 ±0.002 (0.406 ±0.051)
	89	2512	0.250 ±0.002 (6.350 ±0.051)	0.122 ±0.002 (3.099 ±0.051)	0.027 ±0.003 (0.686 ±0.076)	0.017 ±0.002 (0.432 ±0.051)
	68	3939	0.386 ±0.002 (9.804 ±0.051)	0.386 ±0.002 (9.804 ±0.051)	0.030 ±0.005 (0.762 ±0.127)	0.040 ±0.002 (1.016 ±0.051)
	30	5024	0.494 ±0.002 (12.548 ±0.051)	0.243 ±0.002 (6.172 ±0.051)	0.030 ±0.005 (0.762 ±0.127)	0.053 ±0.002 (1.346 ±0.051)
	28	6632	0.666 ±0.002 (16.916 ±0.051)	0.328 ±0.002 (8.331 ±0.051)	0.030 ±0.005 (0.762 ±0.127)	0.063 ±0.002 (1.600 ±0.051)
26	6645	0.666 ±0.002 (16.916 ±0.051)	0.495 ±0.002 (12.573 ±0.051)	0.030 ±0.005 (0.762 ±0.127)	0.063 ±0.002 (01.600 ±0.051)	

¹ Solder may add up to an additional 0.004" in thickness.

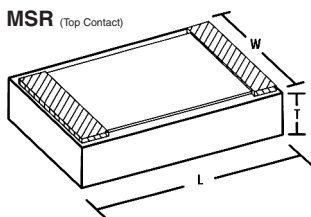

QPL Precision Resistors

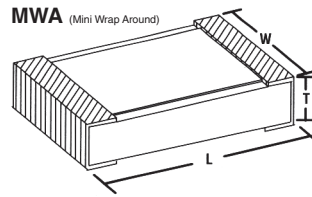
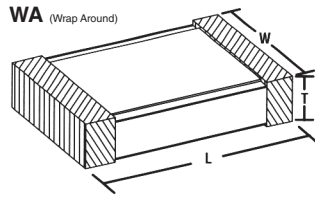
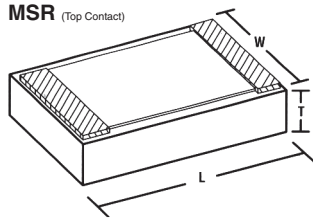

QPL PART NUMBER DESIGNATION

EXAMPLE: M55342M01W10E0S

Per MIL-PRF-55342, TCR ± 300 ppm, 0502 case size, Top Contact, Gold base metal, 10K Ω , 1% tol., "S" Life Failure Rate

MIL-PRF-55342: M55342

D = For /07 series only
 M = all other series
 Military Spec. Indicating
 MIL=PRF-55342

Characteristic: M K = ± 100 ppm
 M = ± 300 ppm
 70 °C Max. ambient temperature at rated wattage

QPL Size: 01 See Tables on pages 16 & 17

Termination: W W = Gold *Top Contact*
Material: T = Platinum Gold *Top Contact*
 Base Metal D = Palladium Silver *Top Contact*
 B = Nickel Barrier, Solder Coated *Wrap Around*
 G = Nickel Barrier, Gold Plated *Wrap Around*
 C = Palladium Silver *Wrap Around*
 U = Platinum Gold *Wrap Around*

Value and: 10E0 10K Ω , 1%
Tolerance See pgs. 14 & 15 for tables III & IV Of MIL-PRF-55342

Life Failure: S C = Non-ER
Rate M = 1.0% / 1000 Hrs.
 Product Level P = 0.1% / 1000 Hrs.
 R = 0.01% / 1999 Hrs.
 S = 0.001% / 1000 Hrs.
 T = Space Level

QPL thick film resistors are printed and fired on 96% Alumina. All case sizes are offered to fit a variety of Hi-Rel hybrid microelectronic applications. Advanced processing techniques and, Hi-Rel Construction assure optimum performance where TCR, VCR and operating power are critical factors. All styles meet and exceed the qualification requirements of MIL-PRF-55342.

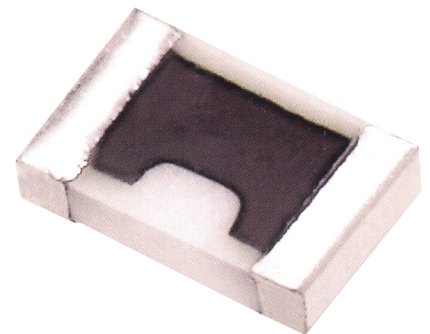
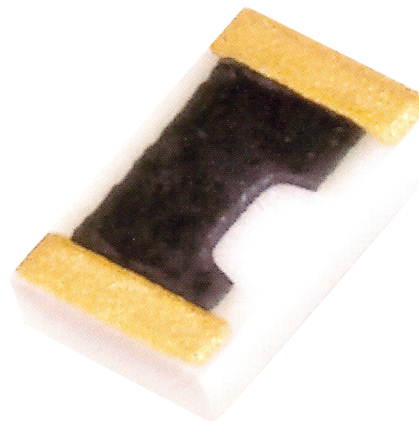

Packaged in chip trays if not specified.

QPL SIZE	QPL STYLE Case Size	TERMINATION	CHAR.	RESISTANCE		TOLERANCE %	POWER (WATTS)	VOLTAGE (VOLTS DC)	MSI SIMILAR STYLE/TYPE
				MIN.	MAX.				
01	RM0502	W, T, D B, G, C, U	K, M	5.60 Ω	1 MΩ	1, 2, 5, 10	0.020	40	MSR81 WA81
02	RM0505	W, T, D B, G, C, U	K, M	5.60 Ω	1 MΩ	1, 2, 5, 10	0.050	40	MSR82 WA82
03	RM1005	W, T, D B, G, C, U	K, M	5.60 Ω	1 MΩ	1, 2, 5, 10	0.100	40	MSR83 WA83
04	RM1505	W, T, D B, G, C, U	K, M	5.60 Ω	4.75 MΩ	1, 2, 5, 10	0.150	40	MSR80 WA80
05	RM2208	W, T, D B, G, C, U	K, M	5.60 Ω	15 MΩ	1, 2, 5, 10	0.225	40	MSR85 WA85
06	RM0705	W, T, D B, G, C, U	K, M	5.60 Ω	1 MΩ	1, 2, 5, 10	0.100	50	MSR86 WA86
07	RM1206	W, T, D B, G, C, U	K, M	5.60 Ω	5.62 MΩ	1, 2, 5, 10	0.250	100	MSR92 WA87
08	RM2010	W, T, D B, C, U	K, M	5.60 Ω	15 MΩ	1, 2, 5, 10	0.800 ¹	150	MSR88 WA88
09	RM2512	W, T, D B, C, U	K, M	5.60 Ω	15 MΩ	1, 2, 5, 10	1.000 ¹	200	MSR89 WA889
10	RM1010	W, T, D B, G, C, U	K, M	5.60 Ω	5.62 MΩ	1, 2, 5, 10	0.500 ¹	75	MSR90 WA90
11	RM0402	W, T, D B, G, C, U	K, M	5.60 Ω	1 MΩ	1, 2, 5, 10	0.040	25	MSR20 WA20
12	RM0603	W, T, D B, G, C, U	K, M	5.60 Ω	1 MΩ	1, 2, 5, 10	0.070	50	MSR93 WA93
13	RM0302	W, T, D B, G, C, U	K, M	5.60 Ω	1 MΩ	1, 2, 5, 10	0.040	15	MSR 98 MWA98

1. Mounted to a ceramic board.

Electrical Performance Characteristics

MIL-PRF-55342	MIL-PRF-55342 Requirement	MSI Typical
Short Term Overload	±0.25%	±0.03%
High Temperature Exposure	±0.50%	±0.05%
Thermal Shock	±0.50%	±0.07%
Low Temperature Operation	±0.25%	±0.05%
Resistance to Bonding Exposure / Soldering Heat	±0.25%	±0.09%
Moisture Resistance	±0.50%	±0.06%
Stability (Life 70°C 2,000Hrs)	±0.50%	±0.04%
Stability (Life 70°C 10,000Hrs)	±2.00%	±0.07%

Operating temperature range from -55°C to +150°C

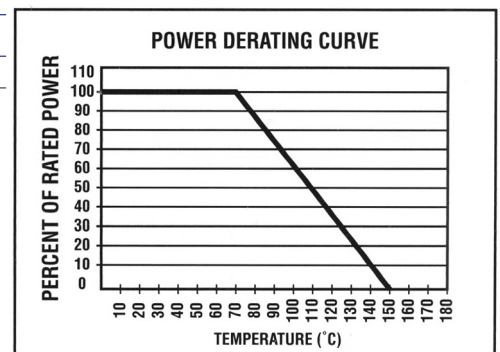

Power rating at 70°C derated linearly to 0% power at 150°C (P=E²/R)

MIL-PRF-55342

TABLE III. Designator or resistance values for resistance tolerances

	Designator for 1 percent tolerance	Resistance Ohms		
Ohms	1D00 to 9D76 inclusive	1.00	to	9.76 inclusive
	10D0 to 97D6 inclusive	10.0	to	97.6 inclusive
	100D to 976D inclusive	100	to	976 inclusive
Kohms	1E00 to 9E76 inclusive	1,000	to	9,760 inclusive
	10E0 to 97E6 inclusive	10,000	to	97,600 Inclusive
	100E to 976E inclusive	100,000	to	976,000 inclusive
Mohms	1F00 to 9F76 inclusive	1,000,000	to	9,760,000 inclusive
	10F0	10,000,000		
	Designator for 2 percent tolerance	Resistance Ohms		
Ohms	1G00 to 9G10 inclusive	1.00	to	9.10 inclusive
	10G0 to 91G0 inclusive	10.0	to	91.0 inclusive
	100G to 910G inclusive	100	to	910 inclusive
Kohms	1H00 to 9H10 inclusive	1,000	to	9,100 inclusive
	10H0 to 91H0 inclusive	10,000	to	91,000 inclusive
	100H to 910H inclusive	100,000	to	910,000 inclusive
Mohms	1T00 to 9T10 inclusive	1,000,000	to	9,100,000 inclusive
	10T0	10,000,000		
	Designator for 5 percent tolerance	Resistance Ohms		
Ohms	1J00 to 9J10 inclusive	1.00	to	9.10 inclusive
	10J0 to 91J0 inclusive	10.0	to	91.0 inclusive
	100J to 910J inclusive	100	to	910 inclusive
Kohms	1K00 to 9K10 inclusive	1,000	to	9,100 inclusive
	10K0 to 91K0 inclusive	10,000	to	91,000 inclusive
	100K to 910K inclusive	100,000	to	910,000 inclusive
Mohms	1L00 to 9L10 inclusive	1,000,000	to	9,100,000 inclusive
	10L0	10,000,000		
	Designator for 10 percent tolerance	Resistance Ohms		
Ohms	1M00 to 8M20 inclusive	1.00	to	8.20 inclusive
	10M0 to 82M0 inclusive	10.0	to	82.0 inclusive
	100M to 820M inclusive	100	to	820 inclusive
Kohms	1N00 to 8N20 inclusive	1,000	to	8,200 inclusive
	10N0 to 82N0 inclusive	10,000	to	82,000 inclusive
	100N to 820N inclusive	100,000	to	820,000 inclusive
Mohms	1P00 to 8P20 inclusive	1,000,000	to	8,200,000 inclusive
	10P0	10,000,000		

MIL-PRF-55342

TABLE IV. Standard resistance values for the 10 to 100 decade

1%	2% & 5%	10%	1%	2% & 5%	10%	1%	2% & 5%	10%
10.00	10.00	10.00	21.50			46.40		
10.20			22.10	22.00	22.00	47.50	47.00	47.00
10.50			22.60			48.70		
10.70			23.20			49.90		
11.00	11.00		23.70			51.10	51.00	51.00
11.30			24.30	24.00		52.30		
11.50			24.90			53.60		
11.80			25.50			54.90		
12.10	12.00	12.00	26.10			56.20	56.00	56.00
12.40			26.70			57.60		
12.70			27.40	27.00	27.00	59.00		
13.00	13.00		28.00			60.40		
13.30			28.70			61.90		
13.70			29.40			63.40	62.00	
14.00			30.10	30.00		64.90		
14.30			30.90			66.50		
14.70			31.60			68.10		
15.00	15.00	15.00	32.40			69.80	68.00	68.00
15.40			33.20	33.00	33.00	71.50		
15.80			34.00			73.20		
16.20	16.00		34.80			75.00	75.00	75.00
16.50			35.70			76.80		
16.90			36.50	36.00		78.70		
17.40			37.40			80.60		
17.80			38.30			82.50	82.00	82.00
18.20	18.00	18.00	39.20	39.00	39.00	84.50		
18.70			40.20			86.60		
19.10			41.20			88.70		
19.60			42.20			90.90		
20.00	20.00		43.20	43.00		93.10	91.00	
20.50			44.20			95.30		
21.00			45.30			97.60		

QPL Precision Resistors

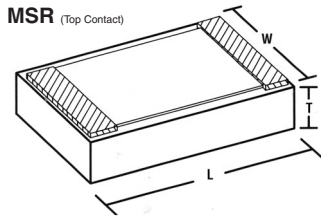

QPL SIZE	QPL STYLE Case Size	Length Inches (mm)	Width Inches (mm)	Pad Width Inches (mm)
01	RM0502	0.050 ±0.005 (1.270 ±0.127)	0.025 ±0.005 (0.635 ±0.127)	0.010 ±0.005 (0.254 ±0.127)
02	RM0505	0.050 ±0.005 (1.270 ±0.127)	0.050 ±0.005 (1.270 ±0.127)	0.010 ±0.005 (0.254 ±0.127)
03	RM1005	0.100 ±0.005 (2.540 ±0.127)	0.050 ±0.005 (1.270 ±0.127)	0.015 ±0.005 (0.381 ±0.127)
04	RM1505	0.150 ±0.005 (3.810 ±0.127)	0.050 ±0.005 (1.270 ±0.127)	0.015 ±0.005 (0.381 ±0.127)
05	RM2208	0.225 ±0.005 (5.715 ±0.127)	0.075 ±0.005 (1.905 ±0.127)	0.015 ±0.005 (0.381 ±0.127)
06	RM0705	0.075 ±0.005 (1.905 ±0.127)	0.050 ±0.005 (1.270 ±0.127)	0.015 ±0.005 (0.381 ±0.127)
07	RM1206	0.126 ±0.005 (3.200 ±0.127)	0.063 ±0.005 (1.600 ±0.127)	0.018 ±0.007 (0.457 ±0.178)
08	RM2010	0.206 ±0.005 (5.232 ±0.127)	0.098 ±0.005 (2.489 ±0.127)	0.015 ±0.005 (0.381 ±0.127)
09	RM2512	0.248 ±0.005 (6.299 ±0.127)	0.124 ±0.005 (3.150 ±0.127)	0.015 ±0.005 (0.381 ±0.127)
10	RM1010	0.100 ±0.005 (2.540 ±0.127)	0.100 ±0.005 (2.540 ±0.127)	0.015 ±0.005 (0.381 ±0.127)
11	RM0402	0.041 ±0.006 (1.041 ±0.152)	0.022 ±0.005 (0.559 ±0.127)	0.010 ±0.005 (0.254 ±0.127)
12	RM0603	0.060 ±0.005 (1.524 ±0.127)	0.032 ±0.005 (0.813 ±0.127)	0.010 ±0.005 (0.254 ±0.127)
13	RM0302	0.032 ±0.004 (0.813 ±0.102)	0.022 ±0.005 (0.559 ±0.127)	0.008 ±0.005 (0.203 ±0.127)

Max Thickness 0.033 in. (0838mm)

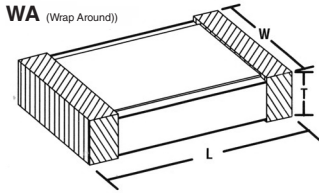

QPL SIZE	QPL STYLE Case Size	Length Inches (mm)	Width Inches (mm)	Pad Width Inches (mm)
01	RM0502	0.055 ±0.006 (1.397 ±0.152)	0.025 ±0.005 (0.635 ±0.127)	0.015 ±0.005 ¹ (0.381 ±0.127)
02	RM0505	0.055 ±0.006 (1.397 ±0.152)	0.050 ±0.005 (1.270 ±0.127)	0.015 ±0.005 ¹ (0.381 ±0.127)
03	RM1005	0.105 ±0.007 (2.667 ±0.178)	0.050 ±0.005 (1.270 ±0.127)	0.015 ±0.005 (0.381 ±0.127)
04	RM1505	0.155 ±0.007 (3.937 ±0.178)	0.050 ±0.005 (1.270 ±0.127)	0.015 ±0.005 (0.381 ±0.127)
05	RM2208	0.230 ±0.007 (5.842 ±0.178)	0.075 ±0.005 (1.905 ±0.127)	0.020 ±0.005 (0.508 ±0.127)
06	RM0705	0.080 ±0.006 (2.032 ±0.152)	0.050 ±0.005 (1.270 ±0.127)	0.015 ±0.005 (0.381 ±0.127)
07	RM1206	0.126 ±0.008 (3.200 ±0.203)	0.063 ±0.005 (1.600 ±0.127)	0.018 ±0.007 ¹ (0.457 ±0.178)
08	RM2010	0.209 ±0.009 (5.309 ±0.229)	0.098 ±0.005 (2.489 ±0.127)	0.020 ±0.005 (0.508 ±0.127)
09	RM2512	0.256 ±0.012 (6.502 ±0.305)	0.124 ±0.005 (3.150 ±0.127)	0.020 ±0.005 (0.508 ±0.127)
10	RM1010	0.105 ±0.007 (2.667 ±0.178)	0.100 ±0.005 (2.540 ±0.127)	0.015 ±0.005 (0.381 ±0.127)
11	RM0402	0.042 ±0.008 (1.067 ±0.203)	0.022 ±0.005 (0.559 ±0.127)	0.010 ±0.005 (0.254 ±0.127)
12	RM0603	0.064 ±0.006 (1.626 ±0.152)	0.032 ±0.005 (0.813 ±0.127)	0.015 ±0.005 ¹ (0.381 ±0.127)
13	RM0302	0.034 ±0.004 (0.864 ±0.102)	0.022 ±0.005 (0.559 ±0.127)	0.008 ±0.005 ¹ (0.203 ±0.127)

Max Thickness 0.033 in. (0838mm)

1. Dimensions are for back terminations only.

Thick film Chip Attenuators



MSA1, MSA3

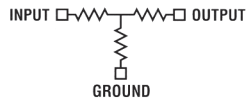
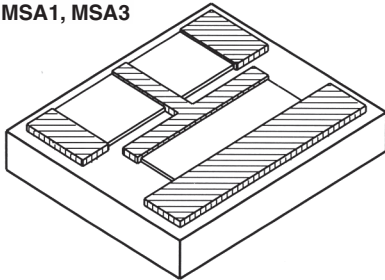

MSA4, MSA5

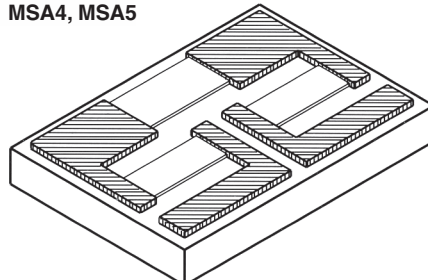

MSA6

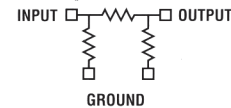
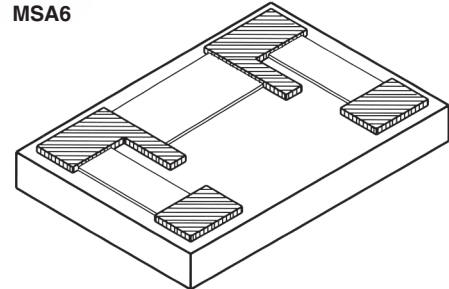

Wire and ribbon bondable and Flipchip thick film chip attenuators, printed and fired on 96% alumina. Provides attenuation accuracy for frequencies through 10 GHz. Double layer terminations provide additional bonding surface. Abrasive trimming ensures optimum resistor stability. Diamond sawed for dimensional uniformity and accuracy. Advanced processing techniques, and Hi-Rel construction assure optimum performance.

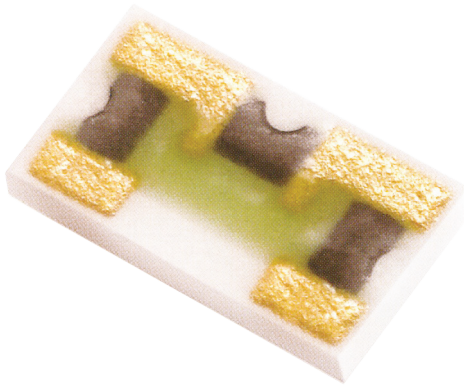

PART NUMBER DESIGNATION

EXAMPLE: MSA3G-01dB-BU

MSA-3 Series, Gold Termination, -1dB, Back Metal, Untinned

Style: MSA Mini-Systems Attenuator

Type: 3 1, 3, 4, 5, 6

Termination: G G = Gold *for wire bonding (MSR only)*
Material PG = Platinum Gold
 Base Metal PS = Palladium Silver

dB Value: 01dB

Metal Options: B B = Back Metal
 Blank = No Metal Options

Options: U U = Untinned No Solder
 S = Soldered
Packaged in chip trays if not specified

MSA1, MSA3

Size	MSA1 = 0.320" X 0.240" X 0.030" (± 0.005 " MSA3 = 0.155" X 0.125" X 0.030" (± 0.005 "
Substrate	96% Alumina
Bond Pads	Wire Bondable, Ribbon Bondable, or Solderable
Attenuation	-1dB Through -20dB
Ranges	Consult Sales For 0.5dB Steps
Attenuation	± 0.5 dB
Accuracy	
Frequency	DC Through 10 GHz
Range	
Impedance	50 Ω
Vswr	1.5:1 Max.
Power	MSA1 = 1W
Rating	MSA3 = 500mW

MSA6

Size	MSA6 = 0.090" X 0.050" X 0.011" (± 0.002 "
Substrate	96% Alumina
Bond Pads	Wire Bondable, Ribbon Bondable, or Solderable
Attenuation	-1dB Through -20dB
Ranges	Consult Sales For 0.5dB Steps
Attenuation	± 0.5 dB
Accuracy	
Frequency	DC Through 10 GHz
Range	
Impedance	50 Ω
Vswr	1.5:1 Max.
Power	MSA6 = 125mW
Rating	Higher power ratings available

Other configurations and impedances are available

MSA4, MSA5

Size	MSA4 = 0.155" X 0.125" X 0.030" (± 0.005 " MSA5 = 0.320" X 0.240" X 0.030" (± 0.005 "
Substrate	96% Alumina
Bond Pads	Wire Bondable, Ribbon Bondable, or Solderable
Attenuation	-1dB Through -20dB
Ranges	Consult Sales For 0.5dB Steps
Attenuation	± 0.5 dB
Accuracy	
Frequency	DC Through 10 GHz
Range	
Impedance	50 Ω
Vswr	1.5:1 Max.
Power	MSA4 = 500mW
Rating	MSA5 = 1W

Thick film Jumpers



These glass insulated, "O-Ohm", gold jumpers are ideally suited for providing interconnections and wiring crossovers in the fabrication of "chip and wire" type microelectronic modules. These jumpers allow for prototype and small quantity circuitry layouts without the need for special conductor patterns.

TJ JUMPER

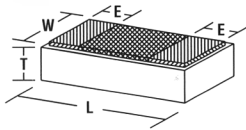

DJ JUMPER

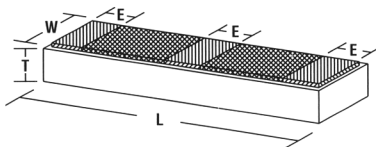

J JUMPER

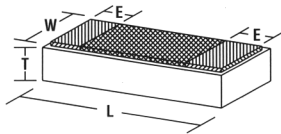

M JUMPER

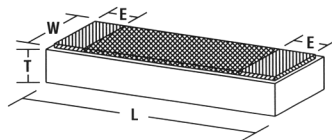

WRAP AROUND JUMPER

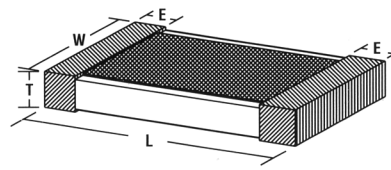

Top Contact Series

Substrate:	96% Alumina <i>Other substrate materials available upon request</i>
Metallization:	Gold; 11 Microns Nominal; <i>Solder Optional</i>
Insulation:	Glass, 10 Microns Nominal
Maximum Current	1.5 Amps

PART NUMBER DESIGNATION

EXAMPLE: TJ-JUMPER

0.045" X 0.017" X 0.011", Jumper, 0.020Ω Max Resistance

Style: TJ TJ, J, MJ, DJ

JUMPER

Style	Length Inches	Width Inches	Thick Inches	Pad		Resistance Max
				Width Inches	Tolerance Inches	
TJ	0.045	0.017	0.011	0.010	±0.002	0.020 Ω
J	0.065	0.017	0.011	0.010	±0.002	0.025 Ω
MJ	0.100	0.017	0.011	0.015	±0.002	0.040 Ω
DJ	0.130	0.017	0.011	0.015 ¹	±0.002	0.050 Ω

Custom sizes available
1. Center pad .010"

Wrap Around Series

Substrate:	96% Alumina <i>Other substrate materials available upon request</i>
Metallization:	Palladium Silver, Platinum Gold. <i>Untinned or solder over nickel barrier optional.</i>
Insulation:	Glass
Maximum Current	1.5 Amps
Maximum Resistance	0.100Ω <i>Values to 0.01Ω available. Contact sales.</i> <i>Values dependant on mounting method</i>

Custom sizes available

PART NUMBER DESIGNATION

EXAMPLE: WAJ81PG-NS62TR

0.055" x 0.025" x 0.017", Pt Gold Term., Ni Barrier, Sn62 Solder, Tape & Reel

Style: WAJ	WAJ = Wrap Around Jumper <i>Please reference WA & MSR Series</i>
Type: 81	See list below
Termination Material	PG = Platinum Gold PS = Palladium Silver <i>Base Metal</i>
Metal/Solder Options	NS62 = Nickel, Sn62 NU = Nickel, Gold Plate S62 = Sn62 U = Untinned <i>No Solder</i>
Option: TR	X = Special requirements <i>Available from sales agent</i> TR = Tape & Reel <i>Package in bulk if not specified</i>

All MSR and WA series resistors are available as jumpers

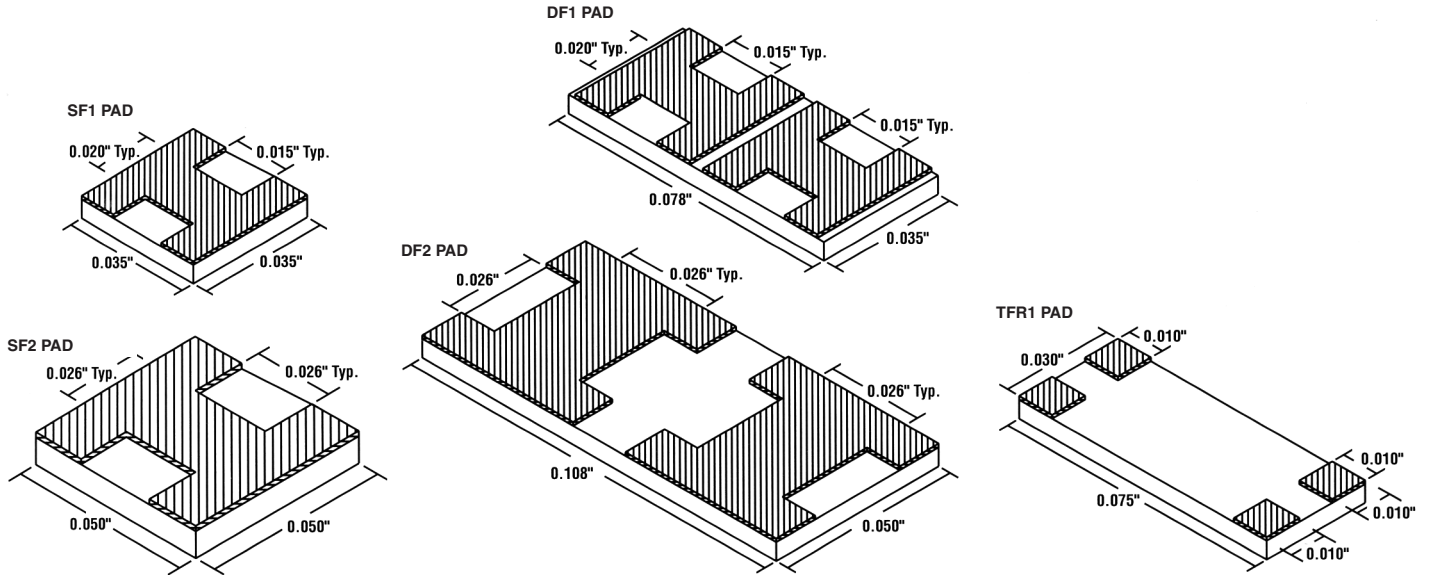

Gold Mounting Pads

Substrate: 96% Alumina

Tolerance: $\pm 0.003''$
On all dimensions

Custom configurations available

PART NUMBER DESIGNATION

EXAMPLE: DF1 PAD

0.078 x 0.035 Mounting Pad

Style: DF DF = Dual
SF = Single
TFR Type 1 only

Type: 1 1 or 2

Option: X X = Special requirements
Available from sales agent
Chip Trays optional
Packaged in bulk if no specified

Jumper & Mounting Pad Kits

Jumper Kit: DJ Jumper = 70 pieces
J Jumper = 100 pieces
MJ Jumper = 100 pieces
TJ Jumper = 100 pieces

Combo Kit: DJ Jumper = 20 pieces
J Jumper = 35 pieces
MJ Jumper = 35 pieces
TJ Jumper = 35 pieces
SF1 Pad = 70 Pieces
DF1 Pad = 35 Pieces
DF2 Pad = 35 Pieces
TFR1 Pad = 35 Pieces

PART NUMBER DESIGNATION

EXAMPLE: JKIT

Style: JKIT JKIT = Jumper Kit
CKIT = Combo Kit

Packaging:

Chip Trays optional

Packaged in bulk if not specified

Custom kits available

Surface Mount Resistor Networks

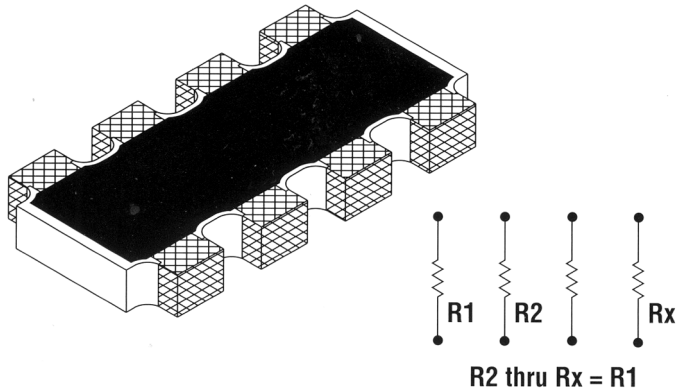

SMR Series of precision resistor networks for fine pitch, surface mount applications. These networks feature a lead pitch of (0.031") and are available in 4 to 16 pin-out styles. The standard value range is 2 Ω to 10 MΩ, isolated resistors. Custom configurations are available. Advanced processing techniques, including abrasively trimmed resistors, ensures maximum performance and stability.

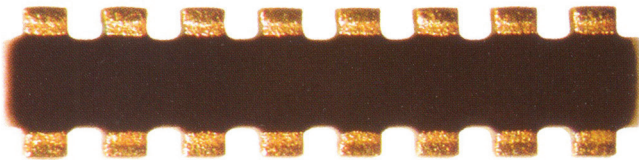

PART NUMBER DESIGNATION

EXAMPLE: SMR8S-1001J-NS62TR

SMR Series, (8) 1 kΩ Resistors, ±5% Abs. Tol., Nickel, Sn62 Solder Tape & Reel

Style: SMR	Surface Mount Resistor
Type: 8	4, 6, 8, 10, 12, 14, 16
Termination: S	Silver
Material	Base Metal
Value: 1001	1 kΩ
<i>Resistance Value</i>	<i>Four digits (xxxx) with provisions for five digits (xxxxx) if necessary. The first three digits represent significant figures. The last digit represents the number of zeros to follow. When fractional values of an ohm are required, the letter "R" is used as a decimal point.</i>
Tolerance: J	J = 5% K = 10% M = 20%
Termination: SN62	NS60 = Nickel Barrier, Sn60 NS62 = Nickel Barrier, Sn62 NS63 = Nickel Barrier, Sn63 NS96 = Nickel barrier, Sn96 NI50 = Nickel Barrier, In50 NI75 = Nickel Barrier, In75 NU = Nickel, Gold Plate
Finish	<i>All come with Nickel</i>
Options: TR	TR = Tape and Reel (<i>Heat seal std</i>) <i>Pressure seal & Paper tape available</i> <i>Packaged in chip trays if not specified</i> X = <i>Special Requirements Code</i>

Style	Type	Number of Resistors	Number of Pin-outs	Length Inches (mm)	Width Inches (mm)	Thickness Inches (mm)
SMR	4	2	4	0.064 ±0.005 (1.626 ±0.127)	0.063 ±0.005 (1.600 ±0.127)	0.020 ±0.005 (0.508 ±0.127)
	6	3	6	0.094 ±0.005 (2.388 ±0.127)	0.063 ±0.005 (1.600 ±0.127)	0.020 ±0.005 (1.508 ±0.127)
	8	4	8	0.126 ±0.005 (3.200 ±0.127)	0.063 ±0.005 (1.600 ±0.127)	0.020 ±0.005 (1.508 ±0.127)
	10	5	10	0.157 ±0.005 (3.988 ±0.127)	0.063 ±0.005 (1.600 ±0.127)	0.020 ±0.005 (1.508 ±0.127)
	12	6	12	0.189 ±0.005 (4.801 ±0.127)	0.063 ±0.005 (1.600 ±0.127)	0.020 ±0.005 (1.508 ±0.127)
	14	7	14	0.220 ±0.005 (5.588 ±0.127)	0.063 ±0.005 (1.600 ±0.127)	0.020 ±0.005 (1.508 ±0.127)
	16	8	16	0.252 ±0.005 (6.401 ±0.127)	0.063 ±0.005 (1.600 ±0.127)	0.020 ±0.005 (1.508 ±0.127)

Mechanical Data

Substrate: 96% Alumina

Optional marking and custom configurations available

Electrical Performance Characteristics

Test per MIL-PRF-55342	MSI Typical
Short Term Overload	±0.03%
High Temperature Exposure	±0.05%
Thermal Shock	±0.07%
Low Temperature Operation	±0.05%
Resistance to Bonding Exposure / Soldering Heat	±0.09%
Moisture Resistance	±0.06%
Stability (Life 70°C 2,000Hrs)	±0.04%
Stability (Life 70°C 10,000Hrs)	±0.07%

Electrical Data

Power Rating	0.063 Watts per resistor ($P = E^2/R$)	
Voltage Rating	40 Volts per Resistor	
TCR:	2 Ω to < 5 Ω:	±300ppm/°C
	5 Ω to < 100 KΩ:	±150ppm/°C
	100 KΩ to < 1 MΩ:	±200ppm/°C
	1 MΩ to < 10 MΩ:	±300ppm/°C

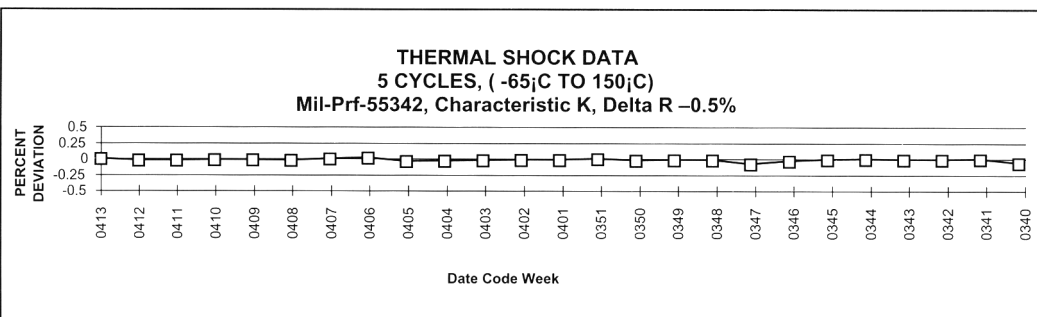
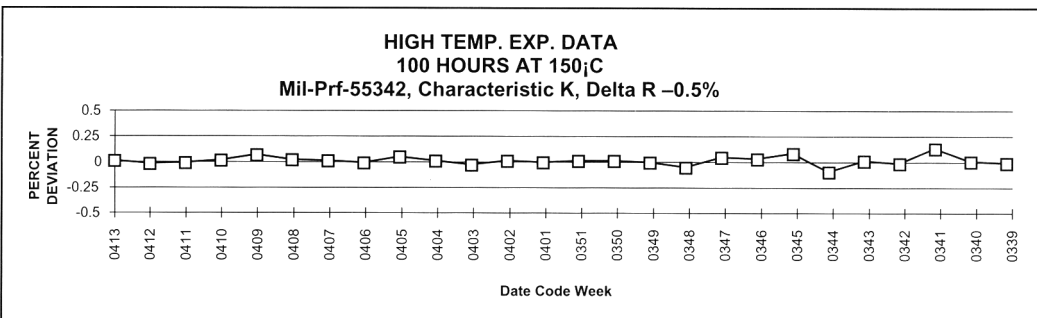
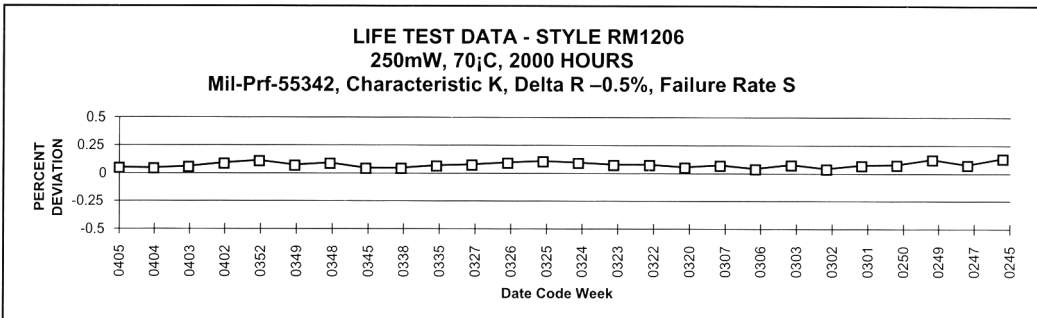
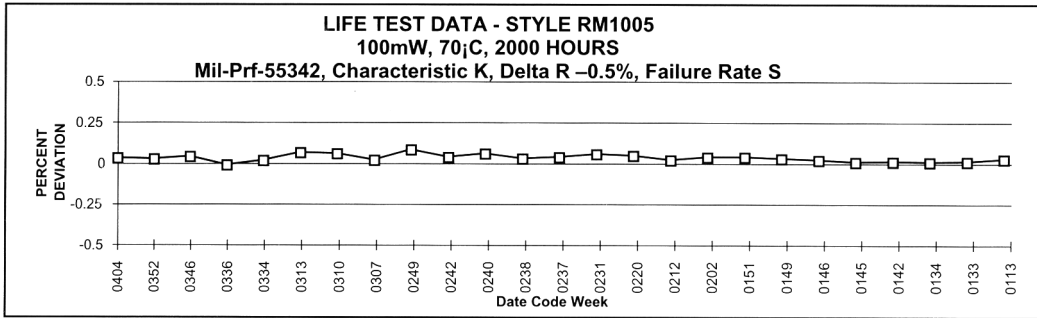

Back page of a Certificate of Conformance, containing data on Thick Film resistor products. Data is continuously updated, and referenced by date code, so that the most recent point is placed at the beginning of the graph

For more information contact the
 MSI Thick Film Quality Assurance Department

Thick Film Products

Wrap Around Resistors

Our five sided wrap around with a double layer termination hermetically seals in the sensitive resistor/conductor interface. This unique construction allows for easier wire bonding and electrical probing. By coupling this multilayer construction with the superior five sided termination, and abrasive trimming, results in a quality product that has higher chip to board adhesion, higher power dissipation, better stability and longer life.

Half Wrap Resistors

MSR Resistors

Top gold pads for wire bonding or solderable top pads for flip chip applications

QPL Approved Products

Approved to all MIL-PRF-55342 style parts
Qualified to "S" Life Failure Rate
Qualified to "T" Space Level

"T" and "PI" Attenuators

Low loss attenuators

Chip Jumpers (Wrap Around & MSR styles)

Ideally suited for interconnections and wiring crossovers

Mounting Pads

Gold pads on ceramic

Jumper Kits and Combo Kits

Surface Mount Resistor Networks

Applications

- ❖ High Reliability Microelectronics
- ❖ Military
- ❖ Biotelemetry
- ❖ Surface Mount
- ❖ Navigation
- ❖ Hybrid
- ❖ Communications
- ❖ Cryogenics
- ❖ Medical Implantable
- ❖ Space
- ❖ Microwave
- ❖ Sensors
- ❖ Research
- ❖ Wireless
- ❖ MCM's
- ❖ Custom

Metallizations

- ❖ Platinum Gold
- ❖ Platinum Gold with Nickel barrier and Gold plate
- ❖ Platinum Gold with Nickel barrier and solder
- ❖ Palladium Silver
- ❖ Palladium Silver with Nickel barrier and Gold plate
- ❖ Palladium Silver with Nickel barrier and solder
- ❖ Gold
- ❖ Silver

Substrates

- ❖ 96% Alumina substrates
- ❖ Also available; black ceramic and beo

Testing Short time overload

- ❖ Resistance to bonding exposure
- ❖ Resistance to soldering heat
- ❖ Thermal shock
- ❖ Temperature cycling
- ❖ Moisture resistance
- ❖ Low temperature operation
- ❖ High temperature exposure
- ❖ Solderability testing
- ❖ Die shear
- ❖ End cap pull
- ❖ Matching and tracking
- ❖ Temperature coefficient of resistance (TCR)
- ❖ Voltage coefficient of resistance (VCR)
- ❖ Life and extended life testing
- ❖ Adhesion, solder mounting integrity
- ❖ Power burn-in
- ❖ Bondability and wire bond integrity testing
- ❖ Steam aging
- ❖ Constant acceleration
- ❖ Cross sectional analysis
- ❖ Resistor noise testing
- ❖ Data logging of DC resistance

Equipment

Screen printing

Systems

- Custom blended pastes
- Substrate size – up to 4" x 6"

Line width definition

- Resistor element geometry down to 0.0007"
- Conductor linewidths to 0.005

Screens

- Sizes up to 8" x 12"

Firing

- ❖ Computer controlled belt furnaces

Trimming

- ❖ Computer controlled abrasive trimmers
- ❖ Trim tolerances to 0.1%
- ❖ Values from 20 mΩ to 100 GΩ

Separation

- ❖ Diamond saw dicing and separation
- ❖ Laser machining available

Die handling and sorting

- ❖ Automatic test and ink marking system
- ❖ Automatic and semiautomatic tape to waffle pack die pickers
- ❖ Tape and reel
- ❖ Wave soldering system
- ❖ Automatic end metallization system

QA Systems

- ❖ 100% Visual per MIL-STD-883, Method 2032
- ❖ 100% DC resistance per MIL-STD-202
- ❖ Complete MIL-PRF-55342 testing capabilities
- ❖ Element evaluation per MIL-PRF-38534, class H and K
- ❖ SPC process monitoring
- ❖ Cross sectional analysis
- ❖ Surface mount reflow soldering
- ❖ Customer selected

Engineering systems

- ❖ Autocad design, file formats handled include DXF & IGES
- ❖ Comprehensive design review and testing

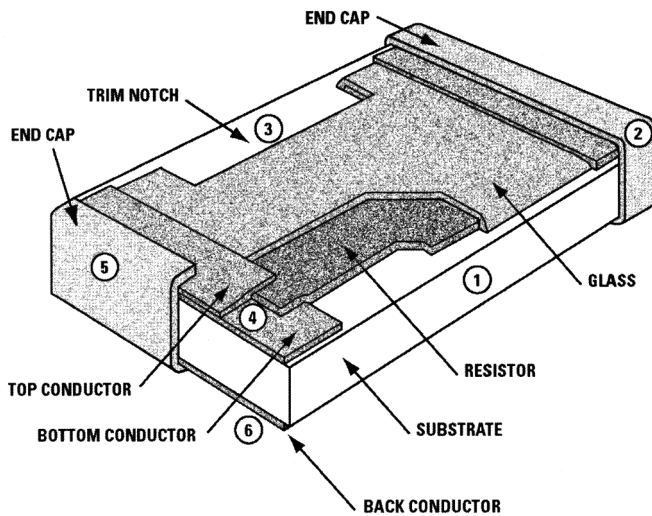

ANATOMY OF A HIGH RELIABILITY THICK FILM CHIP RESISTOR

To illustrate Mini-Systems approach, the following design and fabrication considerations are used for WA, MSR, and QPL series resistors in our thick film processes to maximize the components performance in:

1. Automated Electronic Assembly

Diamond saw die separation tightly controls the resistor's dimensional tolerances, thus improving pick and place assembly by reducing components misplacement and resets.

2. Surface Mount Adhesion

The unique, (5) sided construction of the wrap around termination maximizes component to board solder adhesion in a way that minimizes component tombstoning.

3. Electrical Performance

The fine nozzle, sand blasting method of abrasively trimming resistors results in a component that has lower noise, better short and long term stability, better resistance to voltage pulses, and improved power handling characteristics than a LASER trimmed component.

4. Bondability

All resistors are fabricated with the resistor film sandwiched between a bottom conductor and a top conductor termination. This construction exposes the maximum bond pad area for multiple wire bonds, automated wire bonding and solder coverage. Also inherent to this design is better long term stability, and power handling. Five separate screenings of each part give a consistent and unique advantage.

5. Solderability

Hot solder dip tinning for optimum shelf life and best solder wetting.

6. Chip Attach

Precisely screened-on backside conductors provide a uniform clear space and prevents shorting.

7. Reliability and Testing

Processed materials are continuously tested for mechanical and electrical performance parameters to MIL-PRF55342. Our current DESC failure rating is "S" which represents more than (91) million hours of life testing without a failure.

8. Stray Capacitance

Minimized and consistent by controlled dimensions imparted by (5) precise screenings.

Thin Film

- ❖ The WORLD'S SMALLEST (15Mil²) Chip Resistors
- ❖ Precision Thin Film Chip Resistors and Networks, TCRs to ±5ppm
- ❖ Microwave Resistors, Terminations, Attenuators, and Capacitors
- ❖ Single, Binary, RC, and Networks MOS Capacitors
- ❖ Surface Mount, Packaged and Wire Bondable Configurations

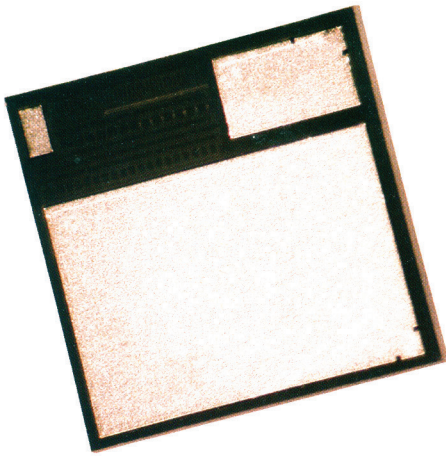

RC Network

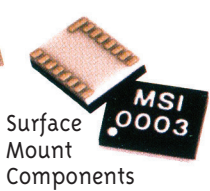

Surface Mount Components

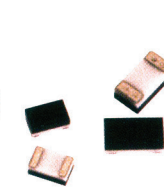

Hi-Meg Resistor

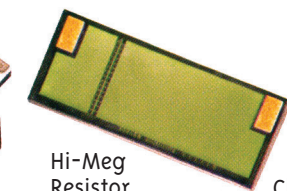

Chip Resistor

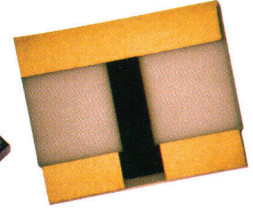

Chip Attenuator

Electronic Package

- ❖ Hermetic Packages – The "ULTIMATE" Device Protection
- ❖ High Performance, Alumina / Glass Walled Flat Packs
- ❖ Plug-in Surface Mount Configurations
- ❖ Microwave Packages, Precision Machined Metal Package
- ❖ Power, Custom, and TO-8 Package
- ❖ Superior Thermal Conductivity

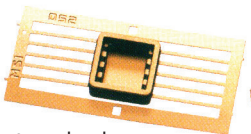

Standard Alumina/Glass Flatpack

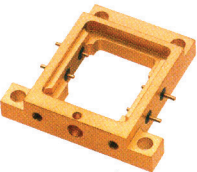

Machined Housing

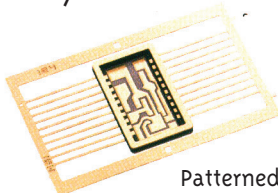

Patterned Alumina/Glass Flatpack



Metal Plug-In

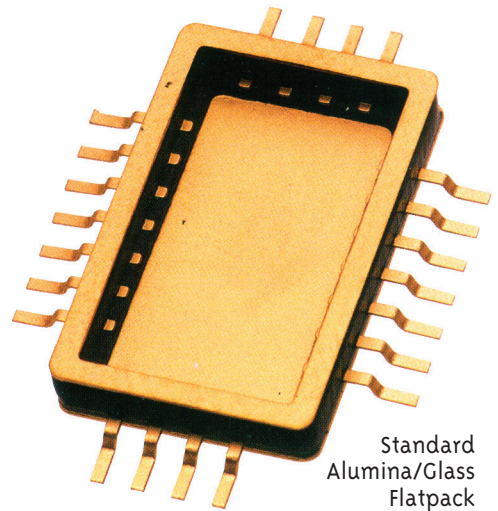

Standard Alumina/Glass Flatpack

Hybrid Assembly

- ❖ Custom Hybrid Circuits, Multi-layers and Resistor Arrays
- ❖ Automatic Wire Bonding/Surface Mount Technology
- ❖ Custom Hermetic, DIL and LIL Packaged Assemblies
- ❖ CAD, Laser Trimming and Marking Services

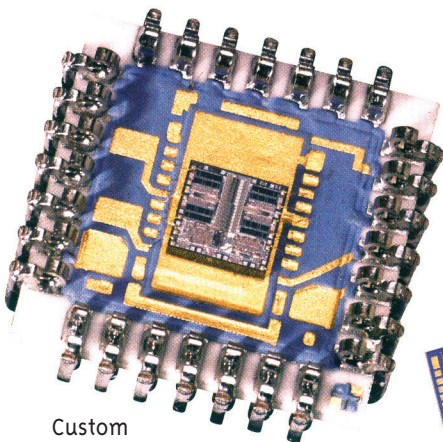

Custom Interface Devices

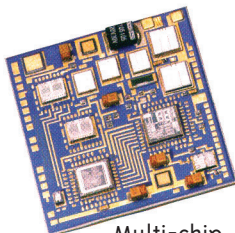

Multi-chip Module

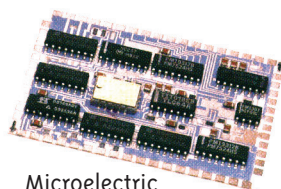

Microelectric Sub-Assemblies

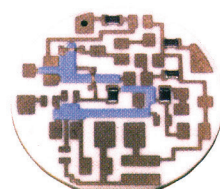

Metallized Ceramics

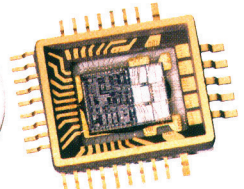

Custom IC Package



MINI-SYSTEMS, INC.

For more product information
and technical assistance,
call, fax, e-mail, or visit web site.
www.mini-systems.com

Thick Film Division

ISO 9001
Certified

20 David Road, PO Box 69
North Attleboro, MA 02761-0069
508-695-0203 Fax 508-695-6076
E-Mail: msithick@Mini-SystemsInc.com

Thin Film Division

ISO 9001
Certified

45 Frank Mossberg Drive, PO Box 1659
Attleboro, MA 02703-0028
508-226-2111 Fax 508-226-2211
E-Mail: msithin@Mini-SystemsInc.com

Electronic Package Division

168 E. Bacon Street, P.O. Box 1597
Plainville, MA 02762-0597
508-695-2000 Fax 508-695-8758
E-Mail: msipkg@Mini-SystemsInc.com

Sunbelt Microelectronic Division

237 Enterprise Road
Deltona, FL 32725-8001
386-574-0208 Fax 386-574-8262
E-Mail: SBMicro@cfl.rr.com



Recipient of Corporate Achievement Award