

### Product Description

Qorvo's QPA1008 is an S-band two stage variable gain driver amplifier in a 5x5 mm QFN. The QPA1008 operates from 2.7 to 3.8 GHz and provides 31dBm of P1dB output power with 26 dB of large signal gain and greater than 30% PAE. The QPA1008 includes a 30 dB attenuator at the input, and a simple resistively coupled (~-20 dB coupling) power sampler detector at the output. The amplifier has a fast bias control switch for quick turn on and off operation.

Lead-free and RoHS compliant.  
Evaluation Boards are available upon request.

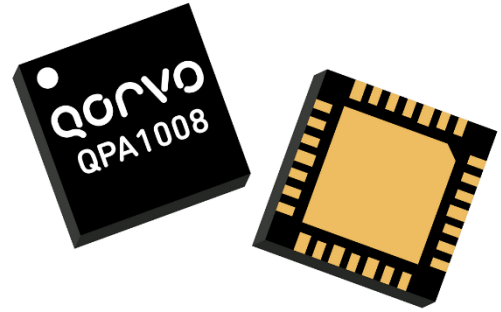

### Product Features

- Frequency Range: 2.7 – 3.8 GHz
- Small Signal Gain: 28 dB
- Input Return Loss: 16 dB
- Output Return Loss: 15 dB
- 32dB Attenuation Range
- P1dB: 31dBm
- Large Signal Gain: 26 dB
- P1dB PAE: 35 %
- Bias Switching Speed: 20 nS
- Bias:  $V_{CC} = 6\text{ V}$ ,  $I_{CQ} = 400\text{ mA}$
- Package Dimensions: 5.0 x 5.0 x 0.82 mm

*Performance is typical across frequency. Please reference electrical specification table and data plots for more details.*

### Functional Block Diagram

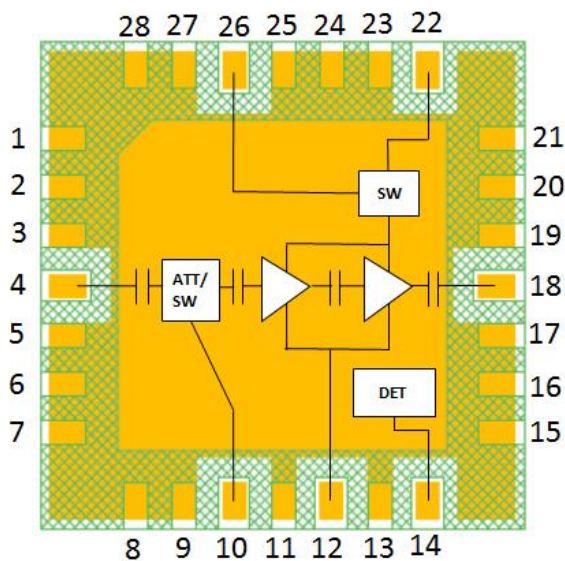

### Applications

- Commercial & Military Radar
- Communications
- Test Instrumentation

### Ordering Information

Part	ECCN	Description
QPA1008	EAR99	2.7 – 3.8 GHz Driver Amplifier
QPA1008EVB01		Evaluation Board

### Absolute Maximum Ratings

Parameter	Value / Range
Collector Voltage ( $V_{CC}$ )	3.3 V - 7 V
Collector Current ( $I_{CC}$ )	1.2 A
Dissipated Power ( $P_{DISS}$ ), $T_{BASE} = 85\text{ }^{\circ}\text{C}$ , $T_{CH} = 175\text{ }^{\circ}\text{C}$ , CW	3.2 W
Input Power (50 $\Omega$ , 85 $^{\circ}\text{C}$ )	29 dBm
Channel Temperature, $T_{CH}$	175 $^{\circ}\text{C}$
Mounting Temperature (30 seconds)	260 $^{\circ}\text{C}$
Storage Temperature	-55 to 150 $^{\circ}\text{C}$

Operation of this device outside the parameter ranges given above may cause permanent damage. These are stress ratings only, and functional operation of the device at these conditions is not implied.

### Recommended Operating Conditions

Parameter	Value
Collector Voltage ( $V_{CC}$ )	6 V
Collector Current (quiescent, $I_{CQ}$ )	400 mA
Collector Current (under drive, $I_{CD}$ )	1 A
$V_{PD}$	5 V
$V_{SW}$	5 V
TJ Max	165 $^{\circ}\text{C}$
Operating Temperature Range	-40 to 85 $^{\circ}\text{C}$

Electrical specifications are measured at specified test conditions. Specifications are not guaranteed over all recommended operating conditions.

### Electrical Specifications

Test conditions, unless otherwise noted: 25  $^{\circ}\text{C}$ ,  $V_{CC} = 6\text{ V}$ ,  $I_{CQ} = 400\text{ mA}$ ,  $V_{PD} = 5\text{ V}$ ,  $V_{SW} = 5\text{ V}$ , CW

Parameter	Min	Typical	Max	Units
Operating Frequency Range	2.7	3.3	3.8	GHz
Output Power @ 1dB Compression (P1dB)		30.8		dBm
Power Added Efficiency @ 1dB Compression (P1dB)		34.6		%
Small Signal Gain		28		dB
Input Return Loss		16		dB
Output Return Loss		15		dB
OIP3 ( $P_{OUT}/\text{tone} \leq 22\text{ dBm}$ )		42		dBm
IM3 ( $P_{OUT}/\text{tone} \leq 22\text{ dBm}$ )		-37		dBc
Gain Control Range		32		dB
Switching Speed		20		nS
Attenuator / Switch Control ( $V_{SW}$ ) Voltage Range	0		5	V
Small Signal Temperature Coefficient		0.031		dB/ $^{\circ}\text{C}$
Output Power Temperature Coefficient		0.004		dB/ $^{\circ}\text{C}$

### Performance Plots – Small Signal

Test conditions unless otherwise noted: Temp. = 25 °C,  $V_{CC} = 6\text{ V}$ ,  $I_{CQ} = 400\text{ mA}$ ,  $V_{PD} = 5\text{ V}$ ,  $V_{SW} = 5\text{ V}$ , CW

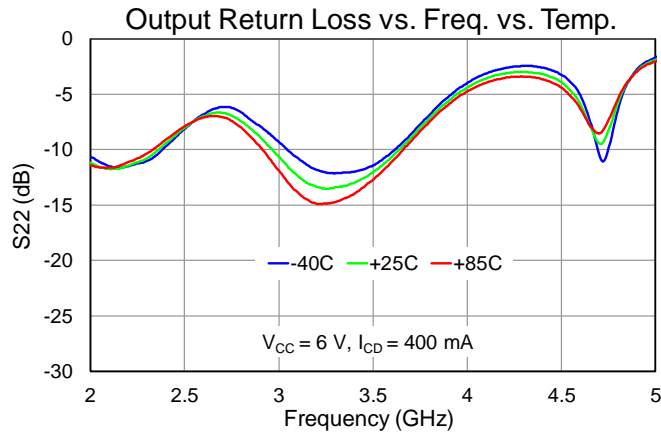
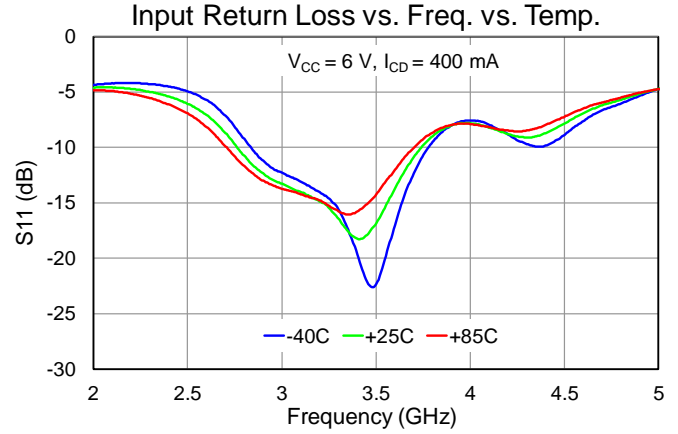
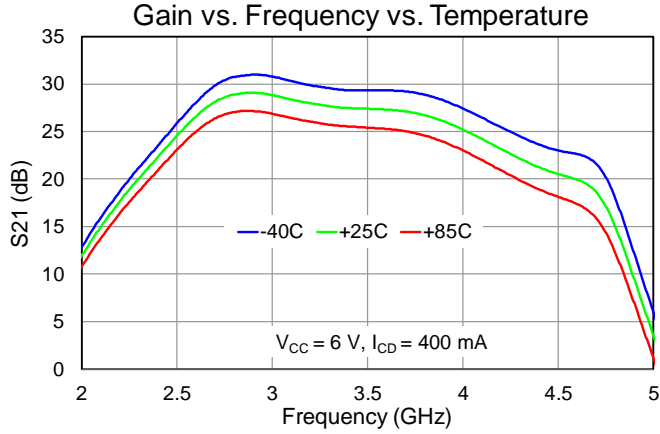

Performance Plots – Large Signal

Test conditions unless otherwise noted: Temp. = 25 °C,  $V_{CC} = 6\text{ V}$ ,  $I_{CQ} = 400\text{ mA}$ ,  $V_{PD} = 5\text{ V}$ ,  $V_{SW} = 5\text{ V}$ , CW

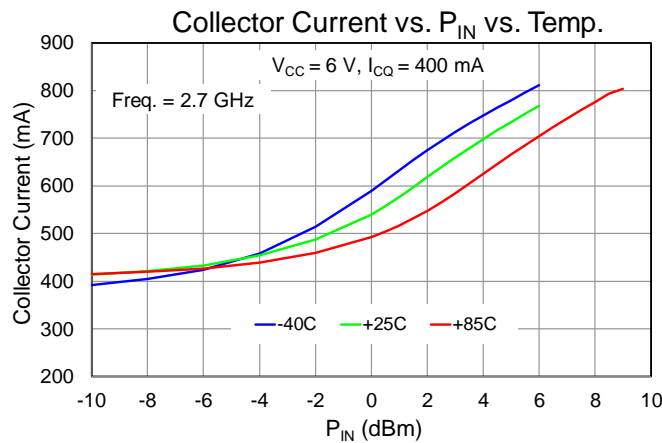
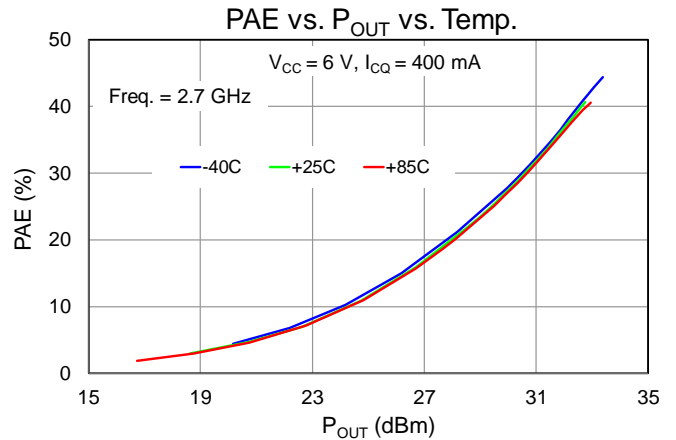
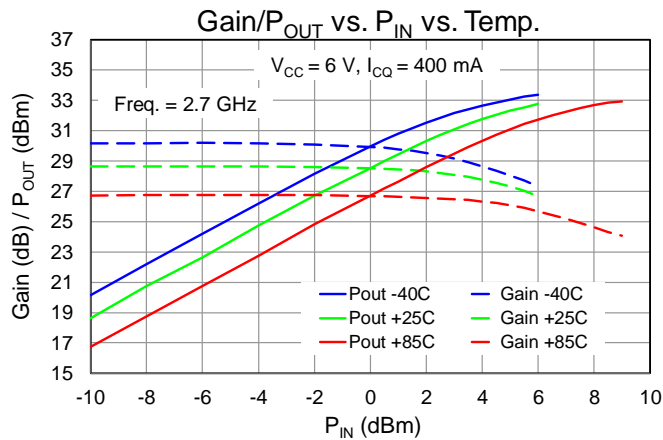
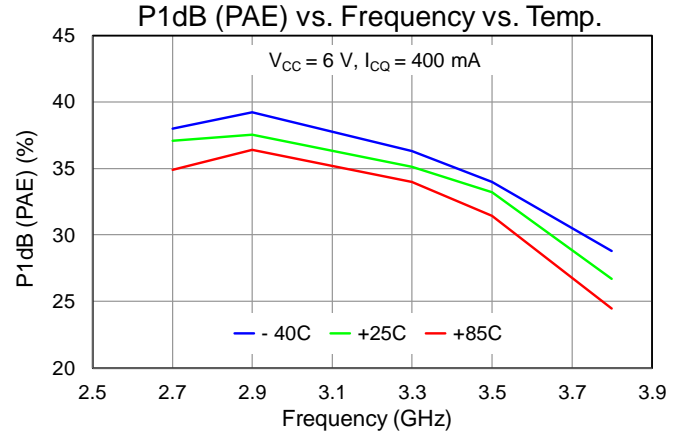
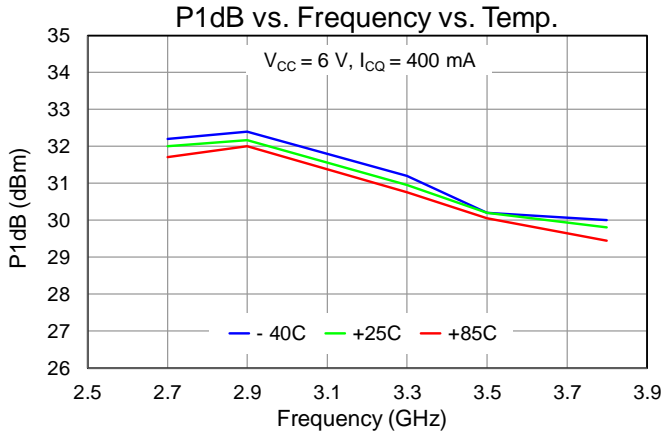

### Performance Plots – Large Signal

Test conditions unless otherwise noted: Temp. = 25 °C,  $V_{CC} = 6\text{ V}$ ,  $I_{CQ} = 400\text{ mA}$ ,  $V_{PD} = 5\text{ V}$ ,  $V_{SW} = 5\text{ V}$ , CW

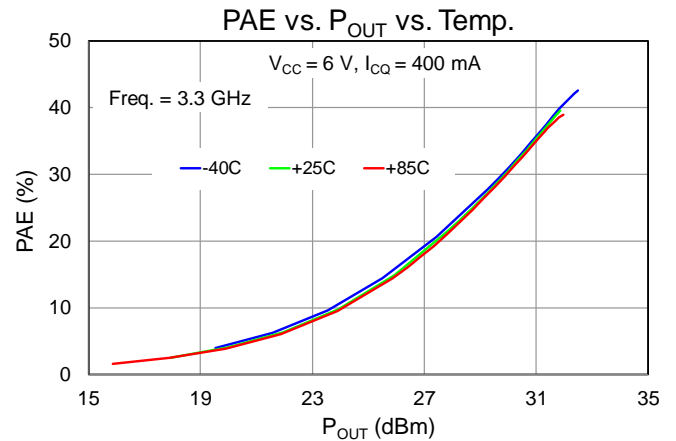
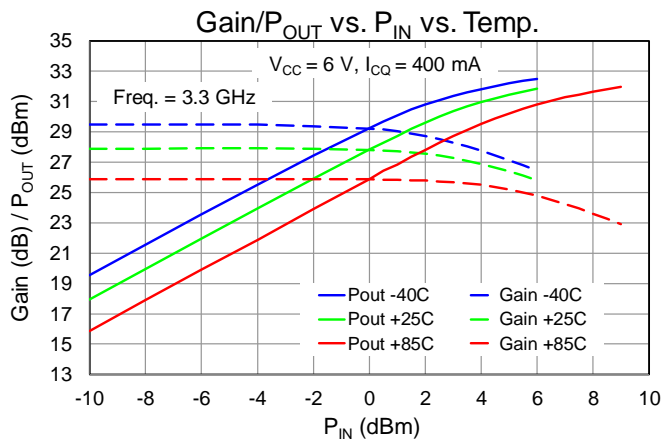
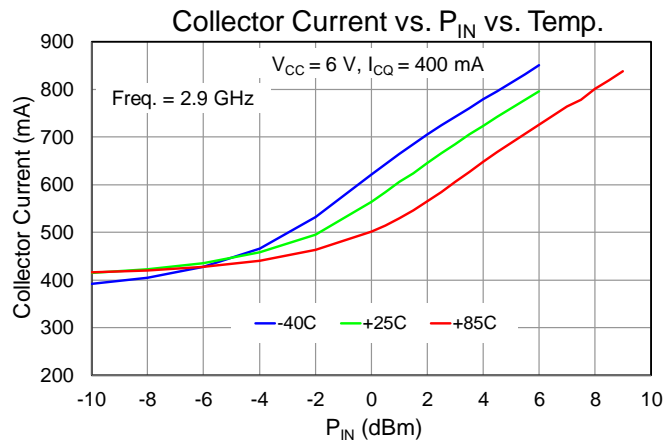
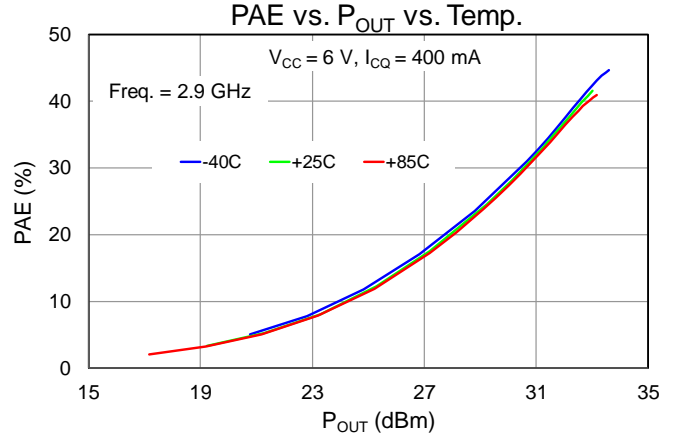
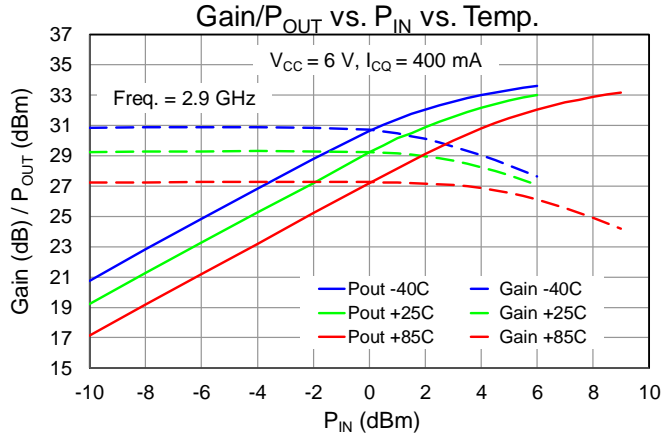

Performance Plots – Large Signal

Test conditions unless otherwise noted: Temp. = 25 °C,  $V_{CC} = 6\text{ V}$ ,  $I_{CQ} = 400\text{ mA}$ ,  $V_{PD} = 5\text{ V}$ ,  $V_{SW} = 5\text{ V}$ , CW

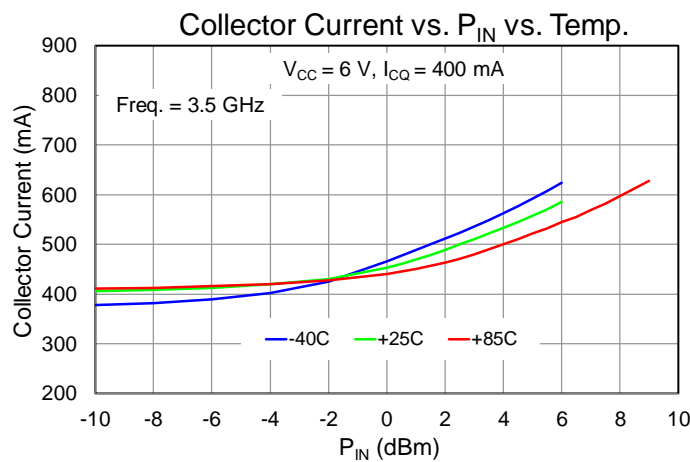
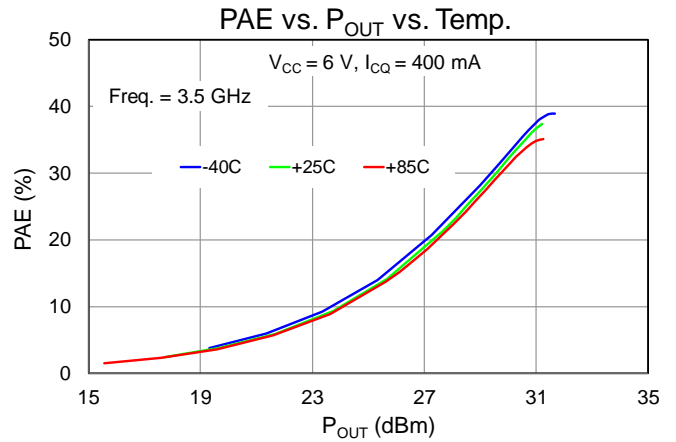
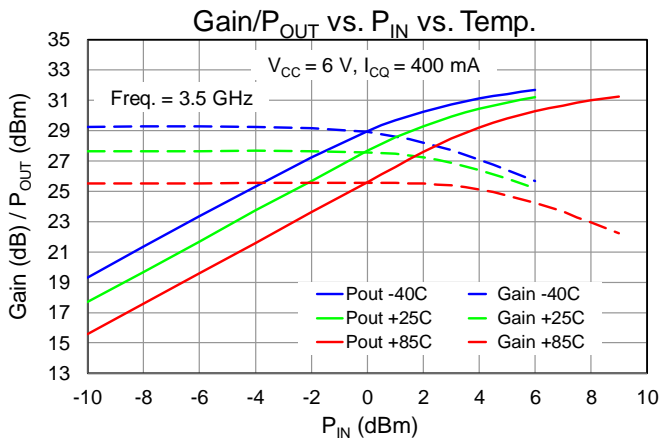
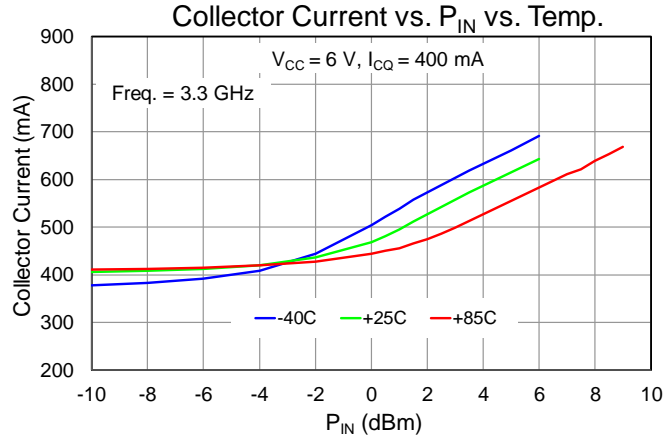

Performance Plots – Large Signal

Test conditions unless otherwise noted: Temp. = 25 °C  $V_{CC} = 6\text{ V}$ ,  $I_{CQ} = 400\text{ mA}$ ,  $V_{PD} = 5\text{ V}$ ,  $V_{SW} = 5\text{ V}$ , CW

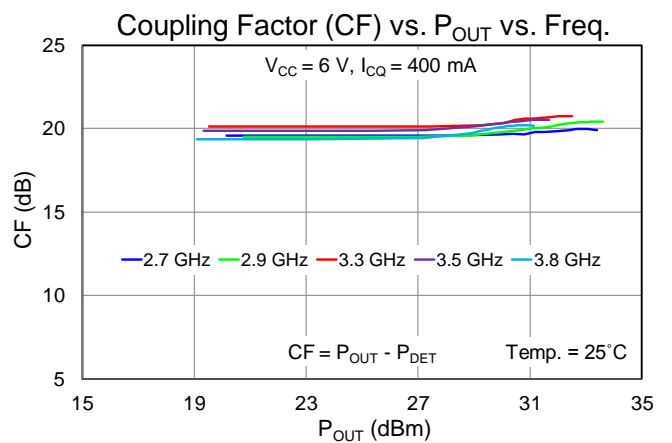
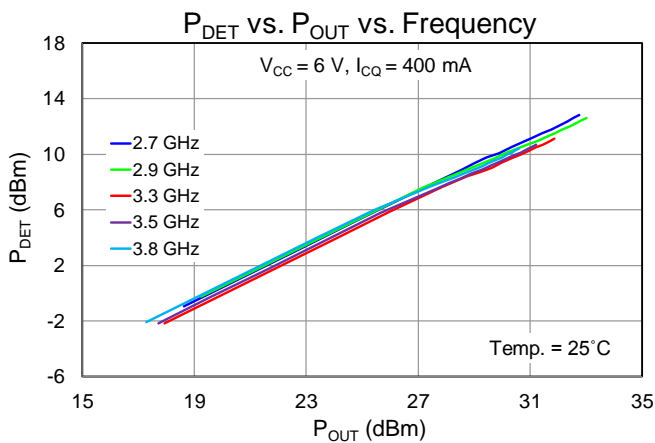
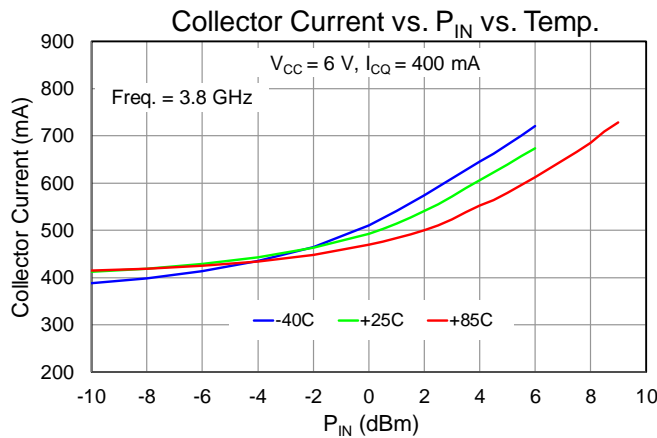
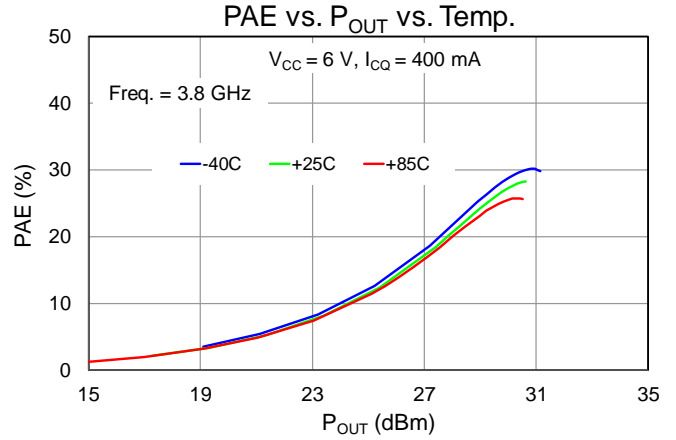
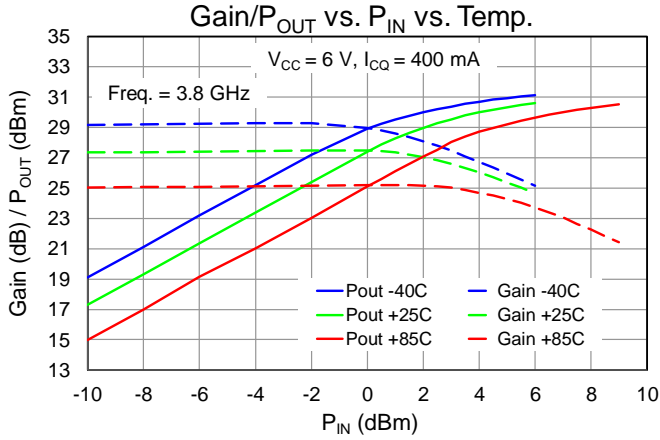

Performance Plots – Large Signal

Test conditions unless otherwise noted: Temp. = 25 °C, V<sub>CC</sub> = 6 V, I<sub>CQ</sub> = 400 mA, V<sub>PD</sub> = 5 V, V<sub>SW</sub> = 5 V, CW

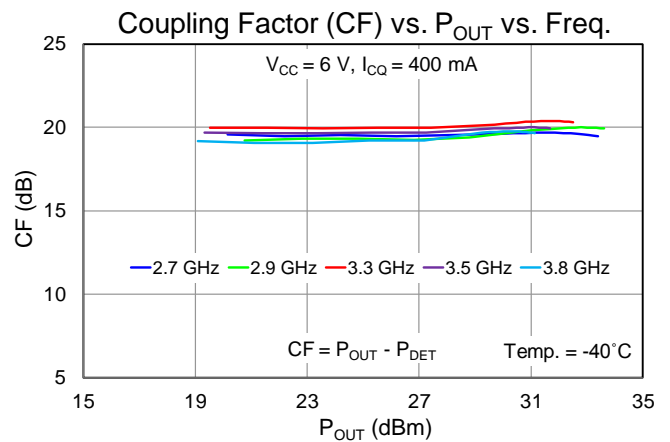
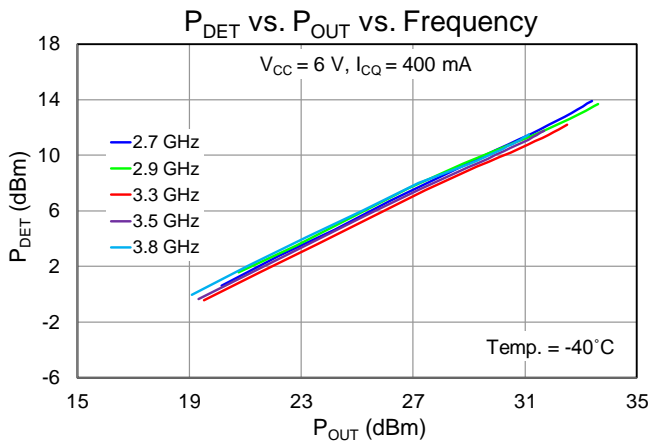
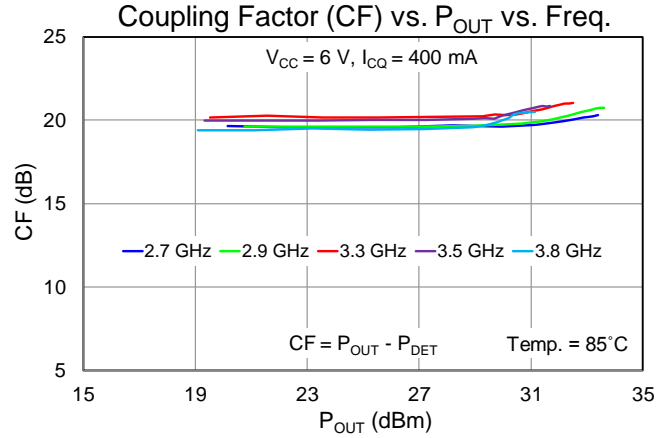
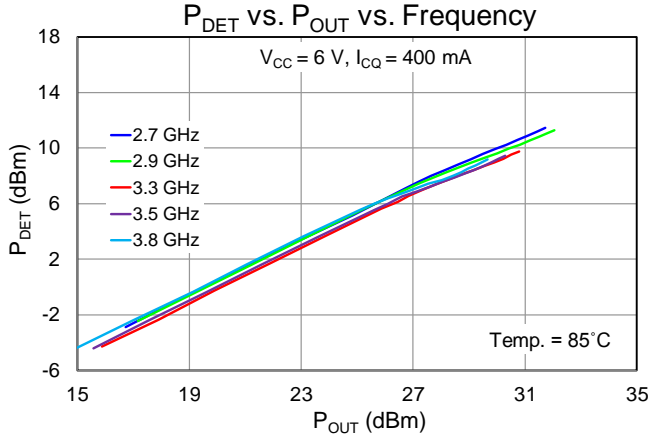

Performance Plots – Linearity

Test conditions unless otherwise noted: Temp. = 25 °C, V<sub>CC</sub> = 6 V, I<sub>CQ</sub> = 400 mA, V<sub>PD</sub> = 5 V, V<sub>SW</sub> = 5 V, CW

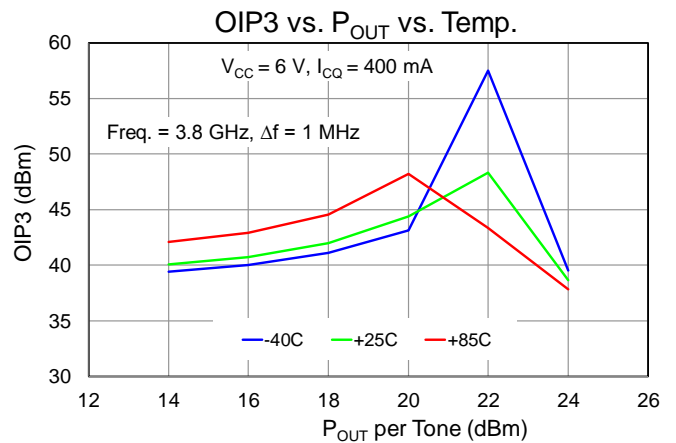
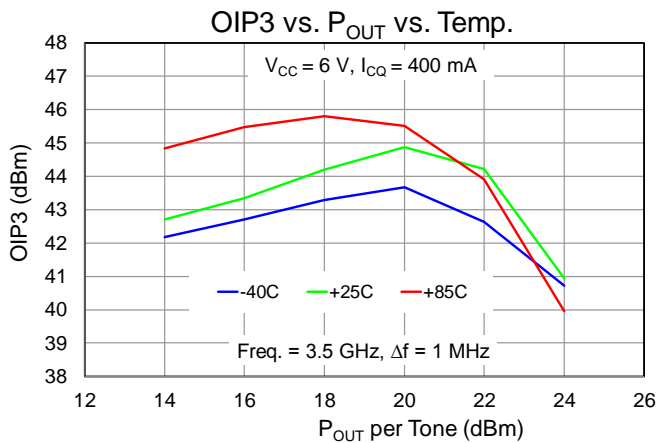
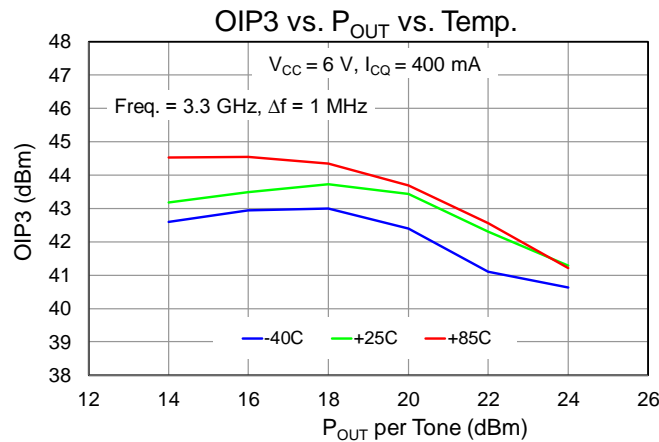
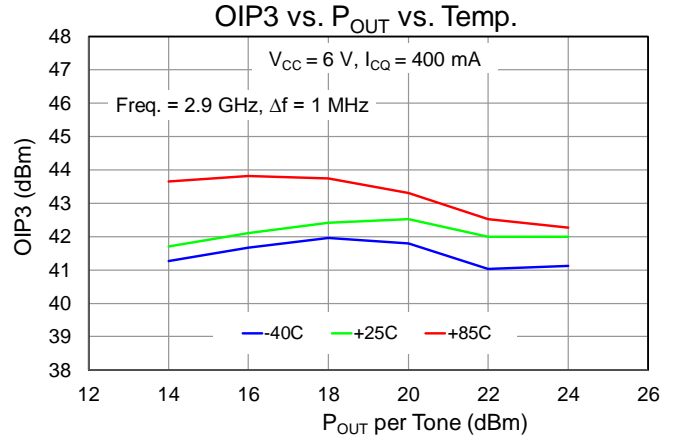
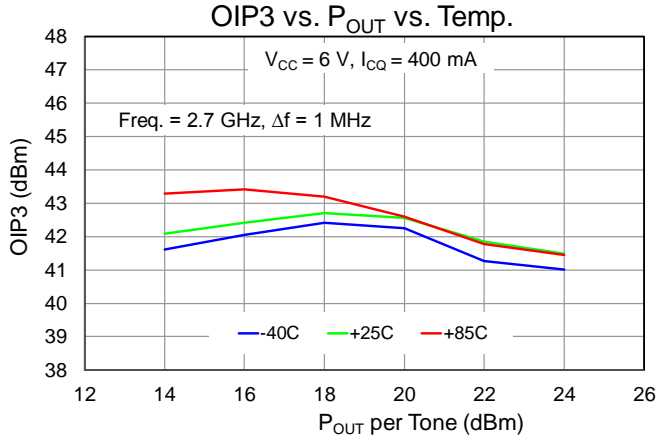

### Performance Plots – Linearity

Test conditions unless otherwise noted: Temp. = 25 °C,  $V_{CC} = 6\text{ V}$ ,  $I_{CQ} = 400\text{ mA}$ ,  $V_{PD} = 5\text{ V}$ ,  $V_{SW} = 5\text{ V}$ , CW

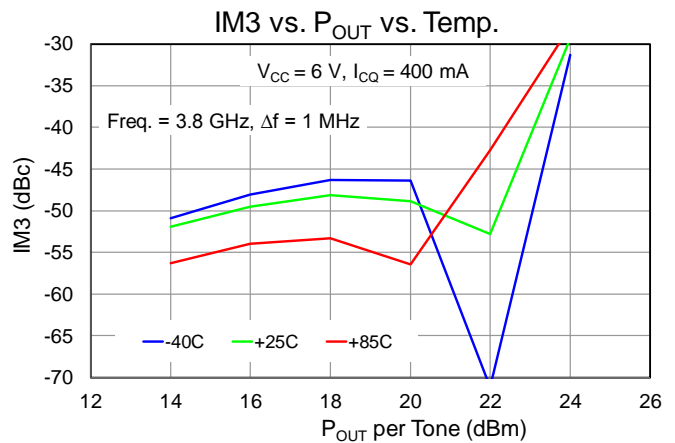
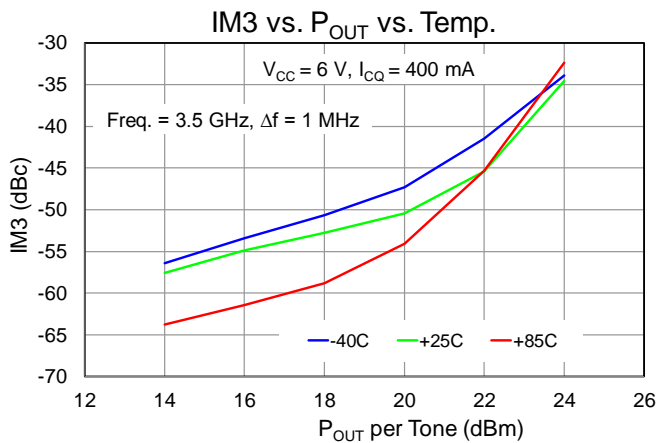
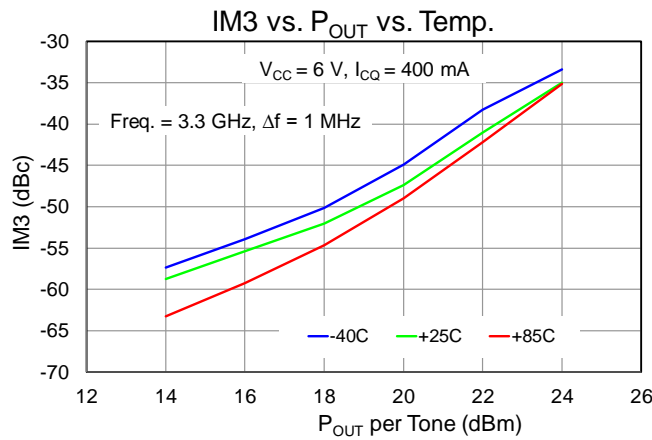
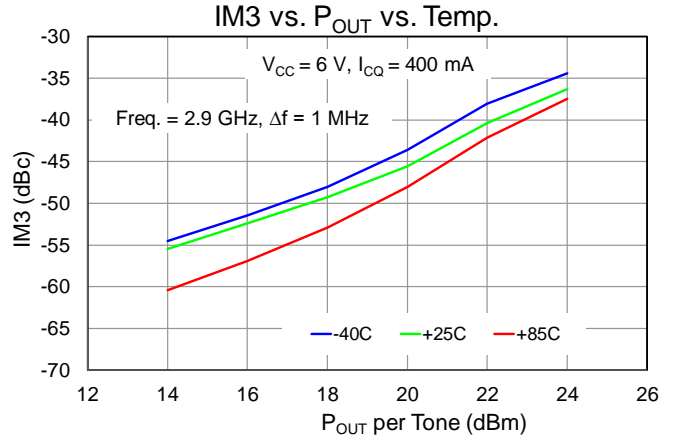
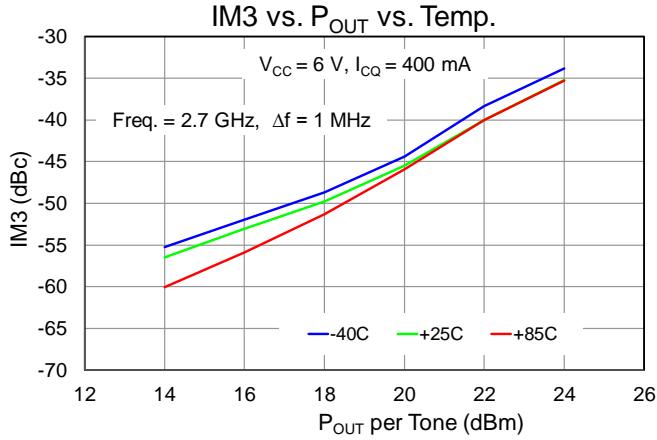

Performance Plots – Attenuation

Test conditions unless otherwise noted: Temp. = 25 °C, V<sub>CC</sub> = 6 V, I<sub>CQ</sub> = 400 mA, V<sub>PD</sub> = 5 V, V<sub>SW</sub> = 5 V, CW

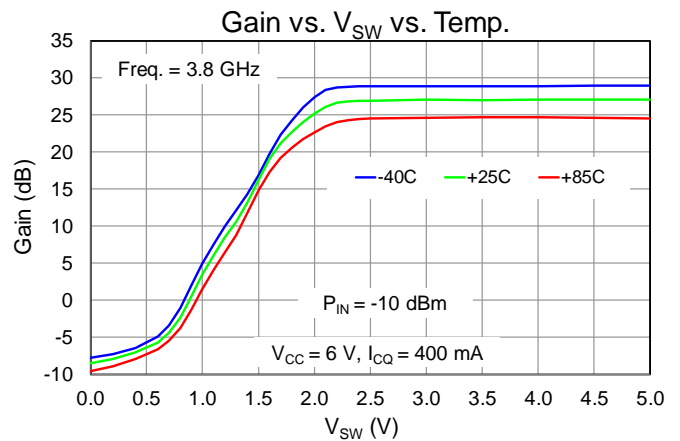
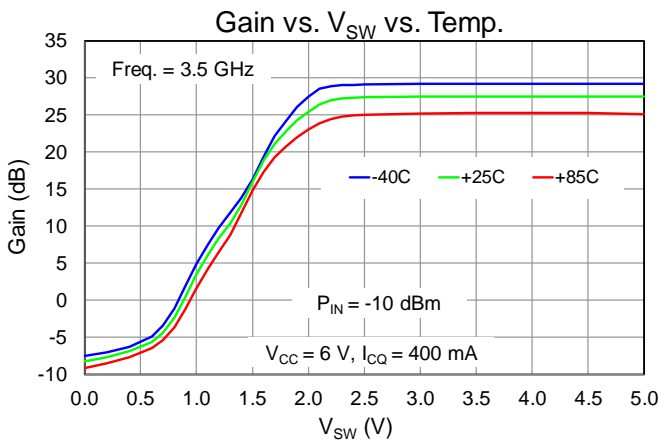
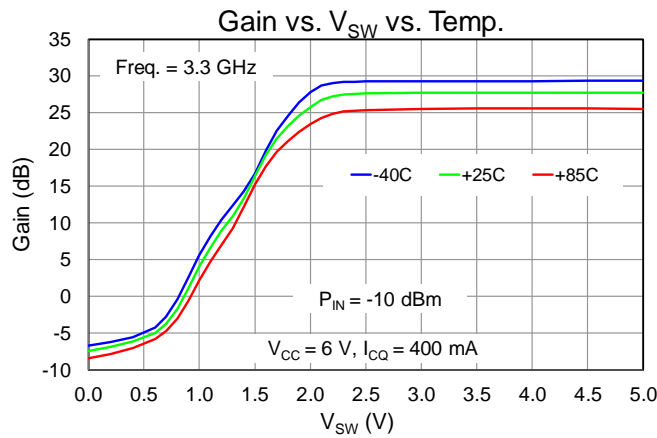
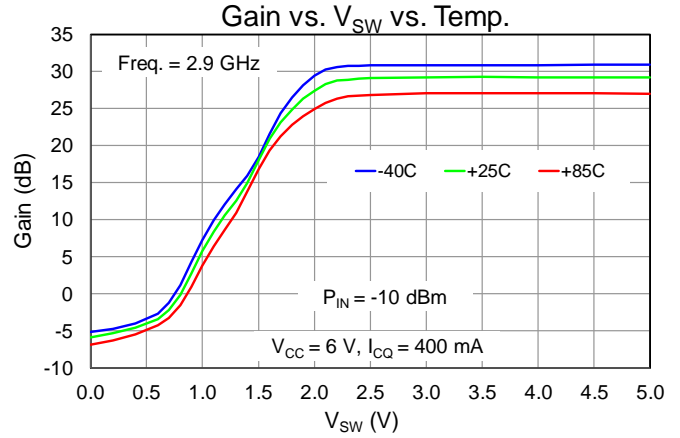
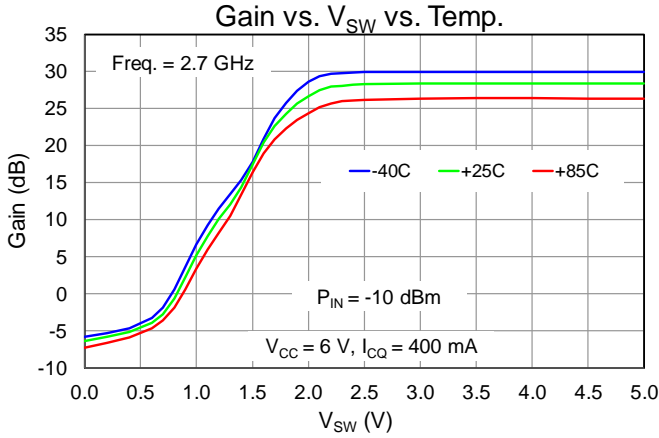

### Thermal and Reliability Information

Parameter	Test Conditions	Value	Units
Thermal Resistance ( $\theta_{JC}$ ) <sup>(1)</sup>	$T_{base} = 85^{\circ}C, T_{case} = 94^{\circ}C$	29.1	$^{\circ}C/W$
Channel Temperature ( $T_{CH}$ ) (Quiescent)	$V_{CC} = 6 V, I_{CQ} = 395 mA,$	165	$^{\circ}C$
Median Lifetime ( $T_M$ )	$V_{PD} = 5V I_{PD} = 13 mA P_{DISS} = 2.44 W$	>8E+7	Hrs
Thermal Resistance ( $\theta_{JC}$ ) <sup>(1)</sup>	$T_{base} = 85^{\circ}C, T_{case} = 97^{\circ}C Freq = 3.8 GHz,$	26.1	$^{\circ}C/W$
Channel Temperature ( $T_{CH}$ ) (Under RF drive)	$V_{CC} = 6 V, I_{CC} = 589 mA,$	163	$^{\circ}C$
Median Lifetime ( $T_M$ )	$V_{PD} = 5V I_{PD} = 13 mA$ $P_{IN} = 4 dBm, P_{OUT} = 30.3 dBm, P_{DISS} = 2.53 W$	>8E+7	Hrs

Notes:

1. Thermal resistance measured to back of EVB.

### Median Lifetime

Test Conditions:  $V_{CC} = +5 V, J_c = 19.5 kA/cm^2$  Failure Criteria = 20 % change in Beta for HBT Technology

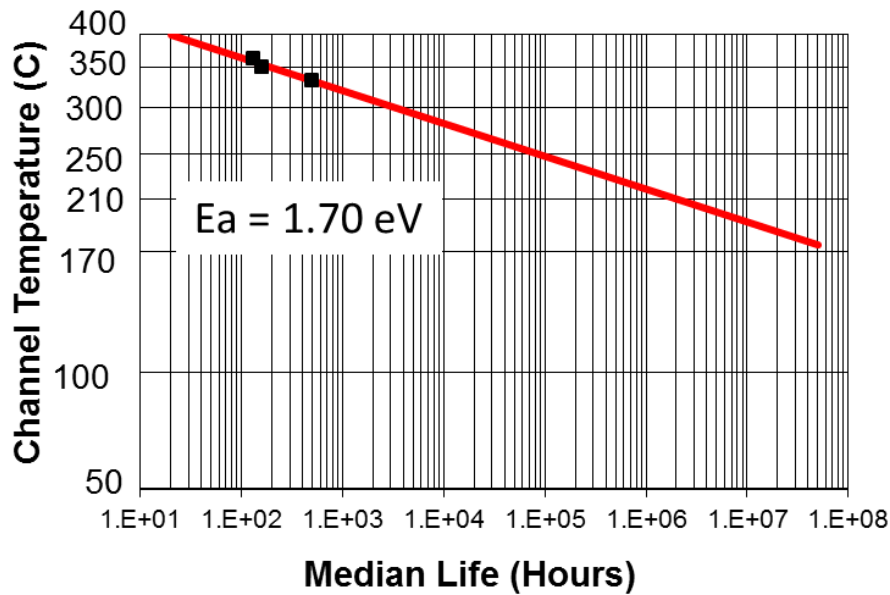

Applications Circuit

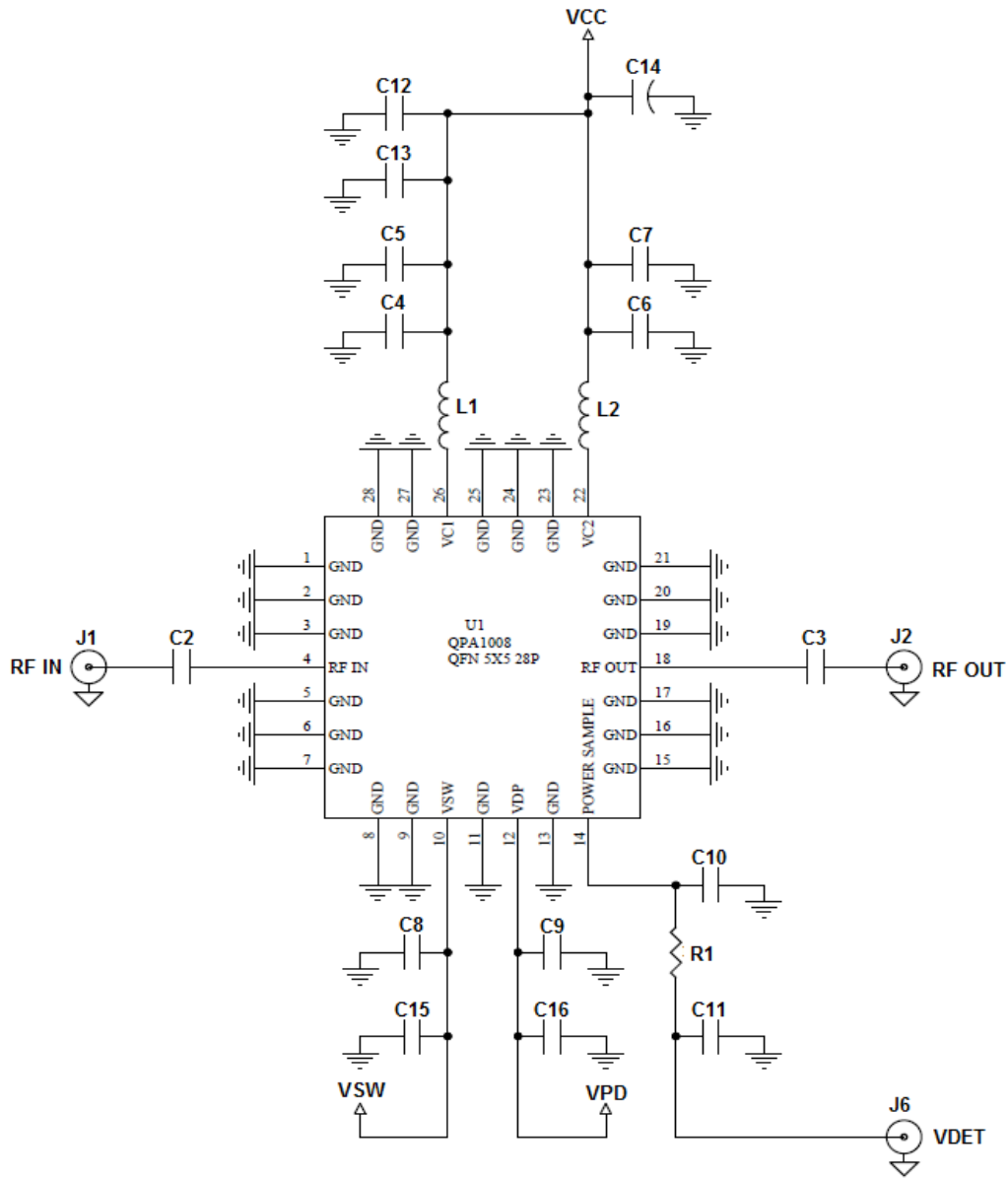

Bias Up Procedure

1. Set I<sub>CC</sub> limit to 1A
2. Set V<sub>CC</sub> to 6 V
3. Set V<sub>PD</sub> to 5 V (Switched bias input)
4. Apply V<sub>SW</sub>:
  - V<sub>SW</sub> = 0 V (Maximum Attenuation)
  - V<sub>SW</sub> = 5 V (Minimum Attenuation)
5. Apply RF signal

Bias Down Procedure

1. RF off signal
2. Turn Off V<sub>PD</sub>
3. Turn Off V<sub>SW</sub>
4. Turn Off V<sub>CC</sub>

### Evaluation Board

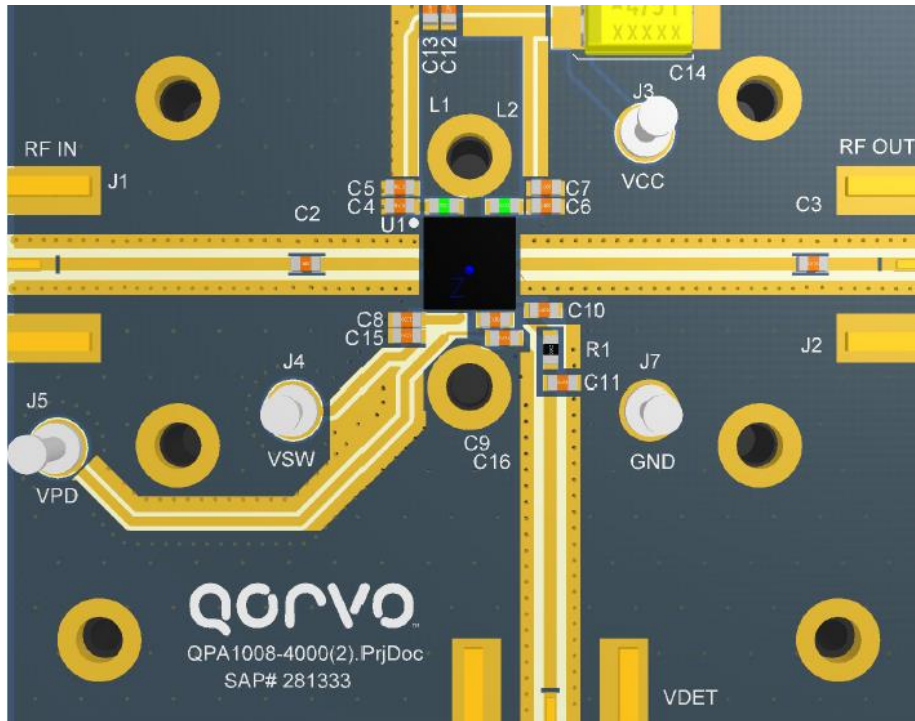

				LAYER 1	0.5 OZ BASE COPPER + PLATING	
	.014	MATL. TYPE	N4000-13	Tg 170 DEG C MIN	LAYER 2	0.5 OZ BASE COPPER
	.028	MATL. TYPE	FR-4	Tg 170 DEG C MIN	LAYER 3	0.5 OZ BASE COPPER
	.014	MATL. TYPE	N4000-13	Tg 170 DEG C MIN	LAYER 4	0.5 OZ BASE COPPER + PLATING

### Qorvo PCB Material and Stack-Up

#### Notes:

If operating near  $P_{SAT}$ , 20 dB (>3W) attenuation pad is recommended at the output of the device to protect test equipment. For this EVB, the Attenuation control is reversed compared to the design requirements and the final production product.

### Bill of Materials

Ref. Des.	Value	Description	Manufacturer	Part Number
U1		QPA1008	Various	
C2, C3, L1, R1	0 $\Omega$	RES, 0603, 1/16 W, Chip	Various	
C4, C6, C9	100 pF	CAP, 0603, 5%, 50 V	Various	
C5, C7, C8	1000 pF	CAP, 0603, 5%, 50 V	Various	
C13	0.1 uF	CAP, 0603, 10%, 50 V, X7R	Various	
C14	10 uF	CAP, 6032, 20%, 50 V, Tantalum	Various	
L2	10 nH	IND, 0603 5%, 4800 MHz	Various	

### PCB Mounting Pattern

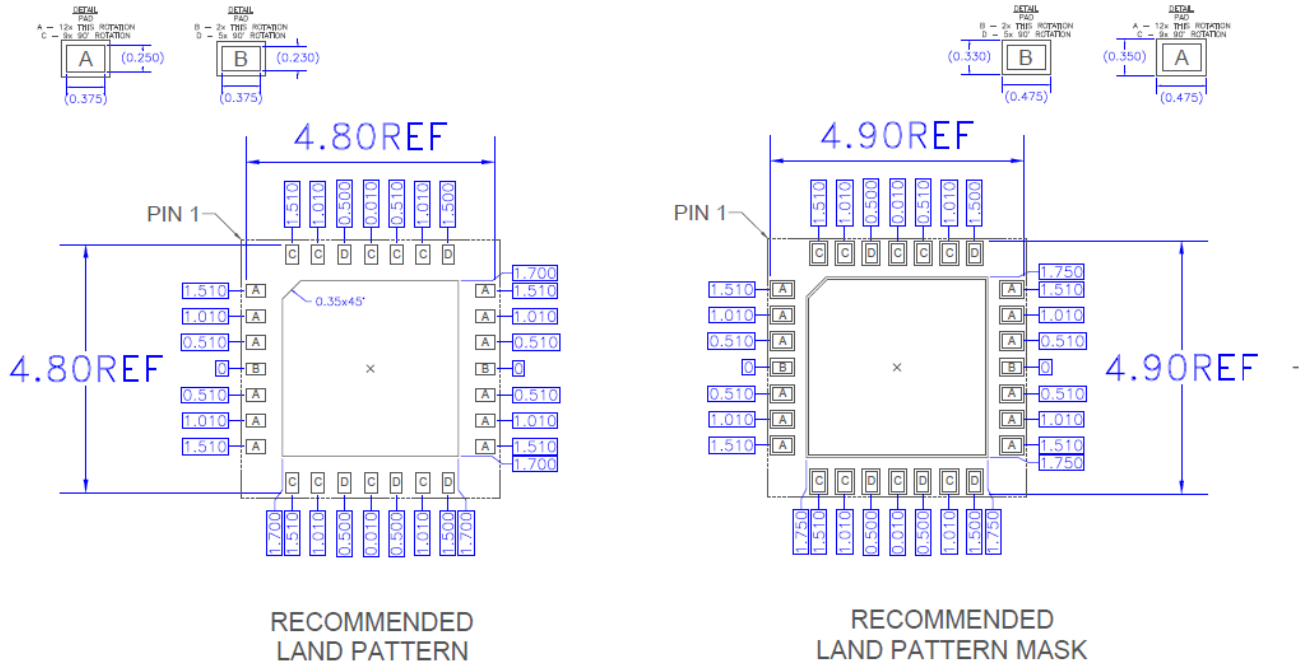

**Recommended PCB land-pad pattern metallization (Top View)**

### Mechanical Information

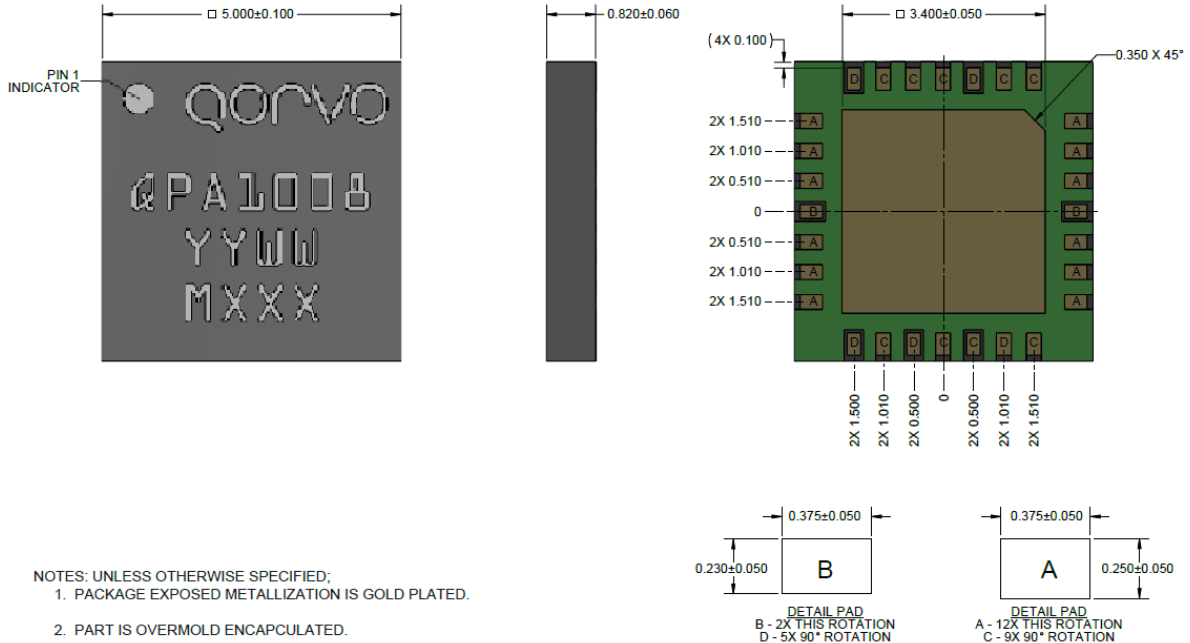

Units: millimeters

Tolerances: unless specified

x.xx = ± 0.25

x.xxx = ± 0.100

Materials:

Base: Laminate

All metalized features are gold plated

Marking:

QPA1008: Part number

YY: Part Assembly year

WW: Part Assembly week

MXXX: Batch ID

**Pad Description**

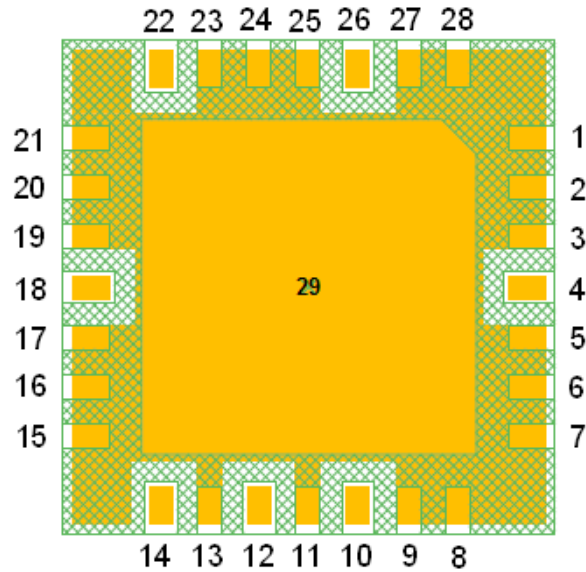

**Bottom view of package base**

Pin Number	Label	Description
1-3, 5-9, 11, 13, 15-17, 19-21, 23-25, 27-28	No Connect	No internal connection. Pads on PCB should be grounded to improve isolation
4	RF Input	RF input, matched to 50 Ω, DC blocked
10	V <sub>SW</sub>	Attenuator Switch Control
12	V <sub>PD</sub>	Bias Switch Control
14	Power Sample	Power Detector, coupled output power (resistive coupler; approximately 20 dB below output power)
18	RF Output	RF output, matched to 50 Ω, DC blocked
22	V <sub>CC2</sub>	Second stage supply voltage. Bias network required
26	V <sub>CC1</sub>	First stage supply voltage. Bias network required
29	GND	Ground paddle; must be grounded using plated through/copper filled via holes on PCB to improve isolation and for heat sinking

**Recommended Soldering Temperature Profile**

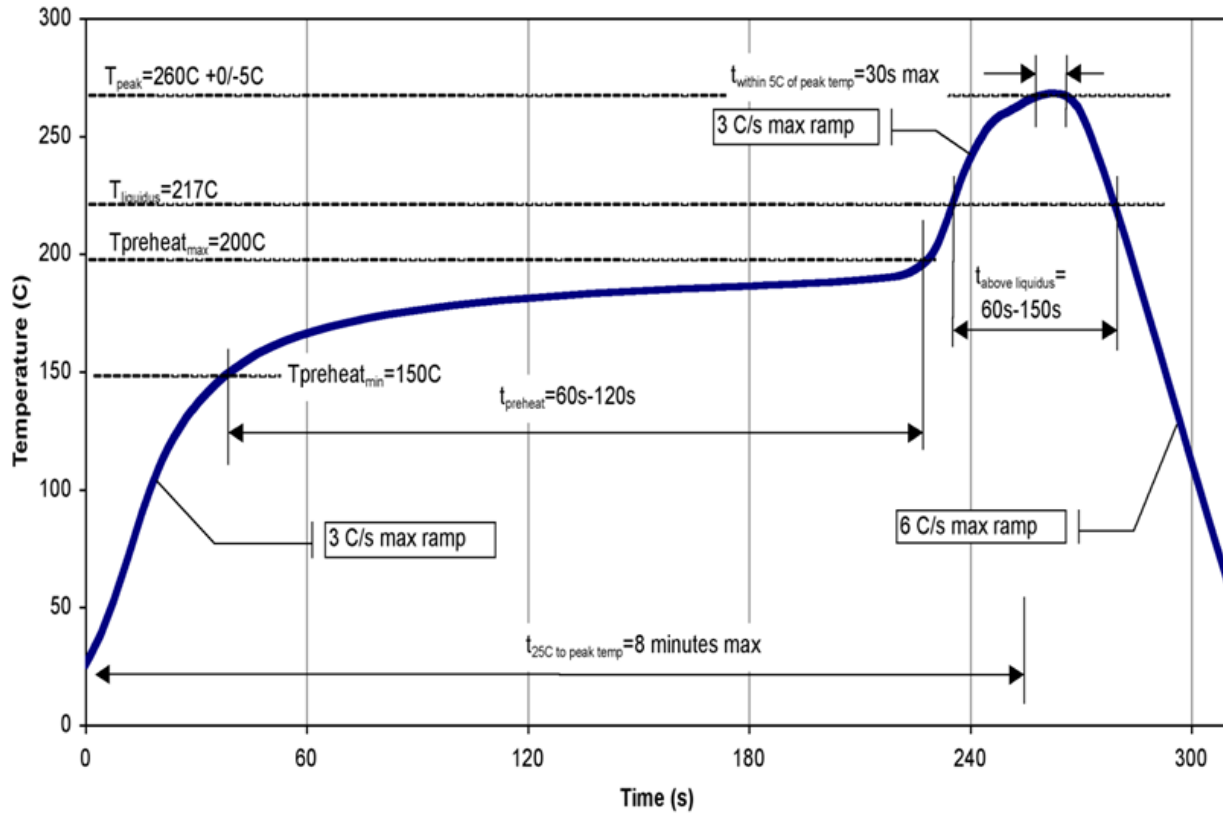

### Handling Precautions

Parameter	Rating	Standard
ESD – Human Body Model (HBM)	Class 1C	ANSI/ESD/JEDEC JS-001
ESD – Charge Device Model (CDM)	Class C3	ANSI/ESD/JEDEC JS-002
MSL – Moisture Sensitivity Level	3	IPC/JEDEC J-STD-020



Caution!  
ESD-Sensitive Device

### Solderability

Compatible with the latest version of J-STD-020 Lead free solder, 260 °C.  
Solder profiles available upon request.

### RoHS Compliance

This product is compliant with the 2011/65/EU RoHS directive (Restrictions on the Use of Certain Hazardous Substances in Electrical and Electronic Equipment), as amended by Directive 2015/863/EU. This product also has the following attributes:

- Lead Free
- Halogen Free (Chlorine, Bromine)
- Antimony Free
- TBBP-A (C<sub>15</sub>H<sub>12</sub>Br<sub>4</sub>O<sub>2</sub>) Free
- PFOS Free
- SVHC Free
- Qorvo Green



### Contact Information

For the latest specifications, additional product information, worldwide sales and distribution locations:

**Tel: 1-844-890-8163**

**Web: [www.qorvo.com](http://www.qorvo.com)**

**Email: [customer.support@qorvo.com](mailto:customer.support@qorvo.com)**

For technical questions and application information: **Email: [appsupport@qorvo.com](mailto:appsupport@qorvo.com)**

### Important Notice

The information contained herein is believed to be reliable; however, Qorvo makes no warranties regarding the information contained herein and assumes no responsibility or liability whatsoever for the use of the information contained herein. All information contained herein is subject to change without notice. Customers should obtain and verify the latest relevant information before placing orders for Qorvo products. The information contained herein or any use of such information does not grant, explicitly or implicitly, to any party any patent rights, licenses, or any other intellectual property rights, whether with regard to such information itself or anything described by such information. **THIS INFORMATION DOES NOT CONSTITUTE A WARRANTY WITH RESPECT TO THE PRODUCTS DESCRIBED HEREIN, AND QORVO HEREBY DISCLAIMS ANY AND ALL WARRANTIES WITH RESPECT TO SUCH PRODUCTS WHETHER EXPRESS OR IMPLIED BY LAW, COURSE OF DEALING, COURSE OF PERFORMANCE, USAGE OF TRADE OR OTHERWISE, INCLUDING THE IMPLIED WARRANTIES OF MERCHANTABILITY AND FITNESS FOR A PARTICULAR PURPOSE.**

Without limiting the generality of the foregoing, Qorvo products are not warranted or authorized for use as critical components in medical, life-saving, or life-sustaining applications, or other applications where a failure would reasonably be expected to cause severe personal injury or death.

Copyright 2016 © Qorvo, Inc. | Qorvo is a registered trademark of Qorvo, Inc.